

Parte esterna termostatico doccia incasso 2 uscite CHRONOS

MODELLO **CR019641**

Parte esterna termostatico doccia incasso 2 uscite, con deviaspout 2 uscite, doccetta monogetto minimale in Ottone, flessibile liscio SUPREME 150 cm, senza parte incasso - per art. ZB019340

FINITURE DISPONIBILI

-  **21** 21 Cromo
-  **2F** 2F Nichel Spazzolato
-  **2Q** 2Q Black Titanium

CARATTERISTICHE

Installazione **Incasso**
 Parti Incasso necessarie **ZB019340**

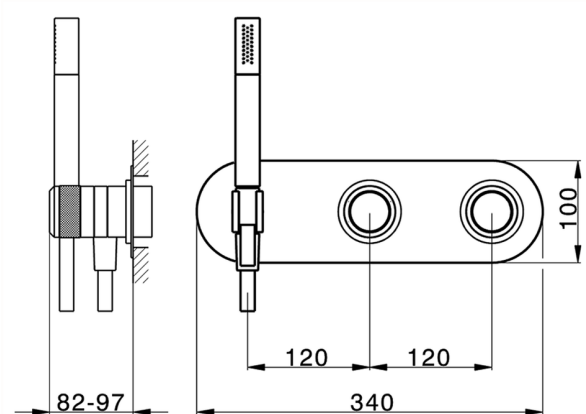

Termostatico

Il Termostatico Huber è il tuo personale gestore dell'acqua che ti aiuta a gestire e controllare acqua ed energia senza sprechi.



Parte incasso termostatico vasca 2 uscite INCASSO

MODELLO **ZB019340**

Parte incasso termostatico vasca 2 uscite, senza parte esterna

FINITURE DISPONIBILI



04 04 Senza Finitura

CARATTERISTICHE

Incasso **1**

Codice Ricambio Cartuccia **24.04A.PP**

Cartuccia Termostatica Plus P 8X20

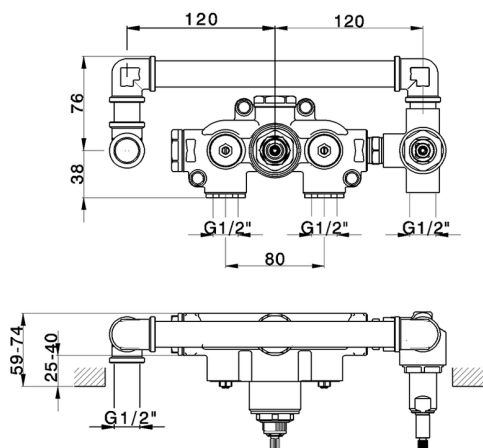

Termostatico

Il Termostatico Huber è il tuo personale gestore dell'acqua che ti aiuta a gestire e controllare acqua ed energia senza sprechi.



2024-06-26