







## Miscelatore termostatico vasca con saliscendi M32\_MTS23016

MODELLO **MTS23016**

Miscelatore termostatico vasca con saliscendi, asta saliscendi 60 cm con supporto scorrevole, doccia monogetto D.23 mm in Ottone, flessibile liscio SUPREME 150 cm

FINITURE DISPONIBILI

-  **21** 21 Cromo
-  **26** 26 Vecchio Rame
-  **2F** 2F Nichel Spazzolato
-  **2W** 2W Oro Spazzolato
-  **40** 40 Nero Opaco
-  **4Q** 4Q Bianco Opaco

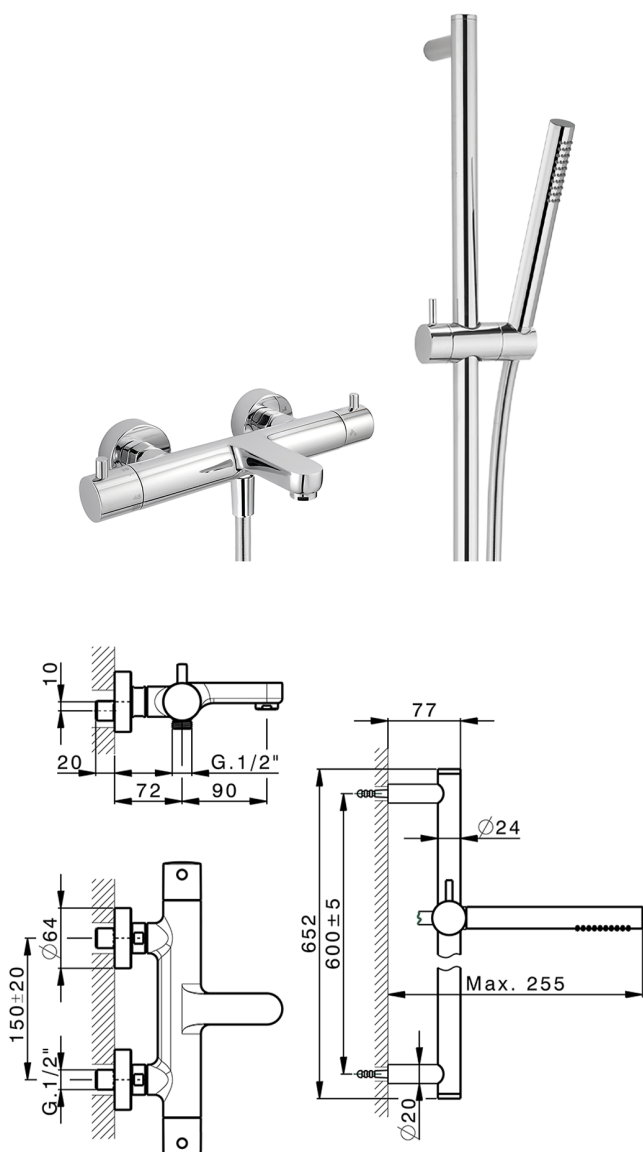

CARATTERISTICHE

Ricambio Cartuccia **22.04A.AR - ZZ97279004**

**Cartuccia Termostatica Argo 2 (filtro lungo)**



### DeviaStop

La tecnologia Devia Stop di Huber consente con un semplice movimento rotativo di gestire la portata dell'acqua e di scegliere la modalità d'erogazione (soffione, doccia a mano).



### SafeTouch

Il sistema SafeTouch Huber mantiene il corpo del miscelatore freddo al tatto durante il funzionamento.



### Termostatico

Il Termostatico Huber è il tuo personale gestore dell'acqua che ti aiuta a gestire e controllare acqua ed energia senza sprechi.



2025-01-05