





Parte esterna lavabo a parete LEVITY

MODELLO **LY013510**

Parte esterna lavabo a parete, senza parte incasso, per art. ZB033511

FINITURE DISPONIBILI

-  **21** 21 Cromo
-  **2B** 2B Nichel Lucido
-  **2F** 2F Nichel Spazzolato
-  **40** 40 Nero Opaco
-  **4Q** 4Q Bianco Opaco

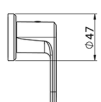
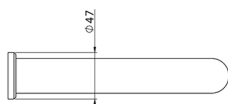
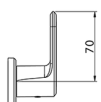
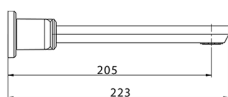
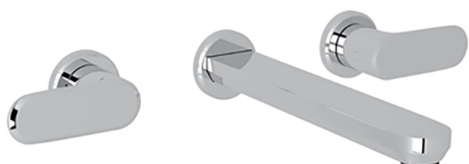

CARATTERISTICHE

Installazione **Incasso**
 Parti Incasso necessarie **ZB033511**



Parte incasso lavabo a parete INCASSO

MODELLO **ZB033511**

Parte incasso lavabo a parete

FINITURE DISPONIBILI

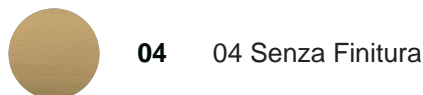

04 04 Senza Finitura

CARATTERISTICHE

Incasso **1**

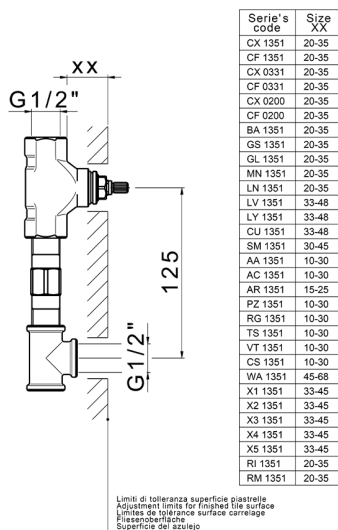

2024-06-26