

## Parte esterna termostatico doccia incasso 2 uscite CHRONOS\_CR019641



MODELLO **CR019641**

Parte esterna termostatico doccia incasso 2 uscite, con deviaspout 2 uscite, doccetta monogetto minimale D.24mm in Ottone, flessibile liscio SUPREME 150 cm, senza parte incasso - per art.ZB019340

### FINITURE DISPONIBILI

-  **21** 21 Cromo
-  **2F** 2F Nichel Spazzolato
-  **2Q** 2Q Black Titanium

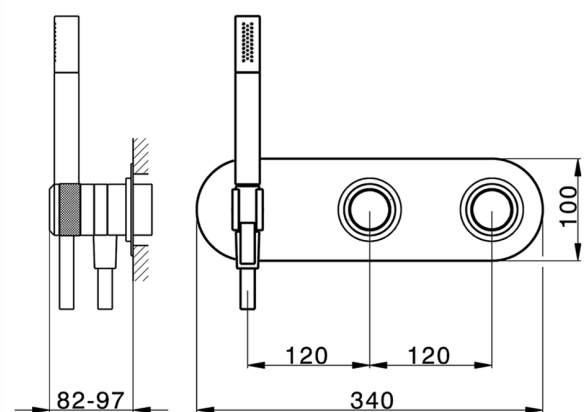

### CARATTERISTICHE

Installazione **Incasso**  
 Parti Incasso necessarie **ZB019340**



### Termostatico

Il Termostatico Huber è il tuo personale gestore dell'acqua che ti aiuta a gestire e controllare acqua ed energia senza sprechi.



**Parte incasso termostatico vasca 2 uscite INCASSO\_ZB019340**
**MODELLO ZB019340**

Parte incasso termostatico doccia 2 uscite, senza parte esterna

**FINITURE DISPONIBILI**

**04** 04 Senza Finitura

**CARATTERISTICHE**

Installazione	<b>Incasso</b>
Ricambio Cartuccia	<b>24.04A.PP</b>
<b>Cartuccia Termostatica Plus P 8X20</b>	
Incasso	<b>1</b>

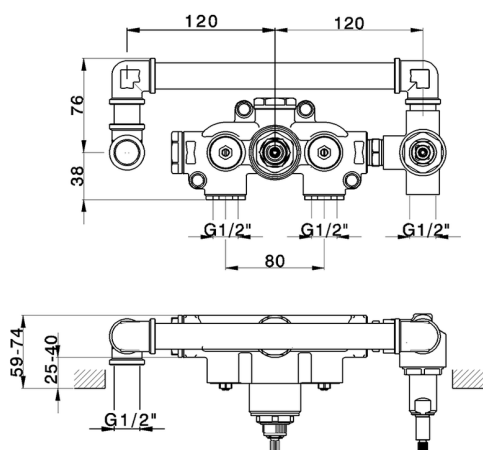
**Termostatico**

Il Termostatico Huber è il tuo personale gestore dell'acqua che ti aiuta a gestire e controllare acqua ed energia senza sprechi.



2025-04-04