



Miscelatore termostatico doccia incasso 3 uscite SUITE_SU008141

MODELLO **SU008141**

Miscelatore termostatico doccia incasso 3 uscite, devia stop 2 uscite, rubinetto d'arresto con uscita 1/2", completo di parte incasso

FINITURE DISPONIBILI

-  **21** 21 Cromo
-  **40** 40 Nero Opaco
-  **2F** 2F Nichel Spazzolato
-  **2W** 2W Oro Spazzolato

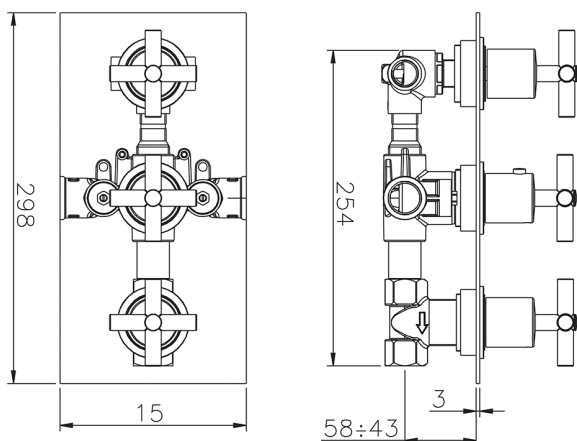

CARATTERISTICHE

Ricambio Cartuccia **24.04A.PP**

Cartuccia Termostatica Plus P 8X20

Installazione **Incasso**



DeviaStop

La tecnologia Devia Stop di Huber consente con un semplice movimento rotativo di gestire la portata dell'acqua e di scegliere la modalità d'erogazione (soffione, doccia a mano).



Termostatico

Il Termostatico Huber è il tuo personale gestore dell'acqua che ti aiuta a gestire e controllare acqua ed energia senza sprechi.



2025-04-04