

Parte esterna termostatico doccia incasso 2 uscite H2_H2018100

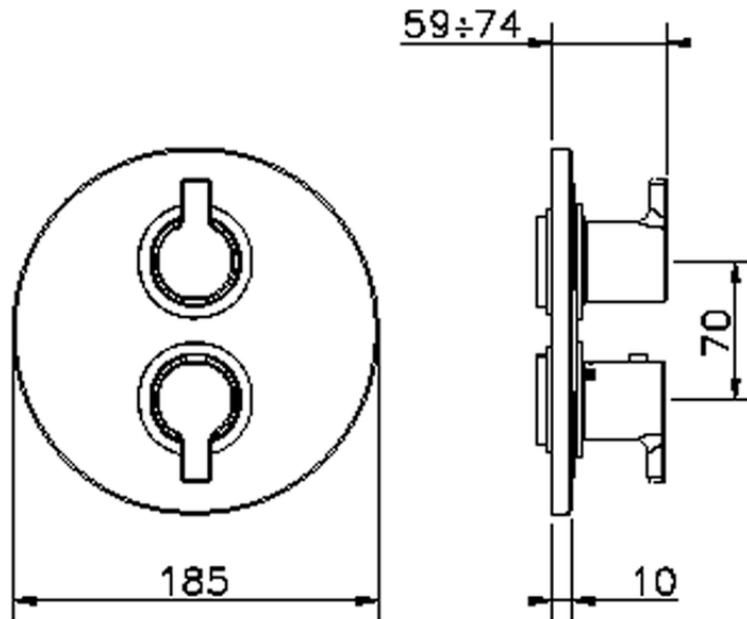

H2018100

<http://www.huberitalia.com/parte-esterna-termostatico-doccia-incasso-2-uscite-h2-h2018100>



Piastra/Plate/Plaque/Platte/Placa

2-3mm: XX 25-40 YY 76-91

10 mm: XX 16-31 YY 65-80

ZB018101

<http://www.huberitalia.com/parte-incasso-termostatico-doccia-2-uscite-incasso-zb018101>

2025-01-02