

## Parte esterna monocomando lavabo a parete HARLOCK\_HC005515

MODELLO **HC005515**

Parte esterna monocomando lavabo a parete, senza parte incasso, bocca L.250 mm, per art. Easy-Box ZB002450 e art. ZB025510

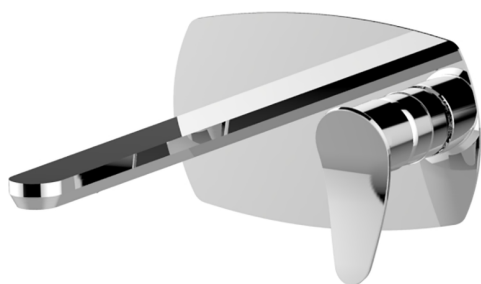

### FINITURE DISPONIBILI

-  **21** 21 Cromo
-  **2P** 2P Oro Rosa
-  **2Q** 2Q Black Titanium
-  **40** 40 Nero Opaco
-  **4Q** 4Q Bianco Opaco
-  **6T** 6T Cromo/Nero Opaco

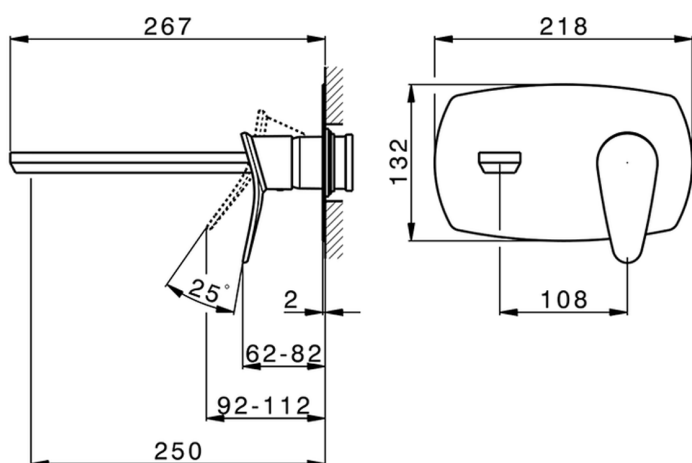

### CARATTERISTICHE

Installazione **Incasso**  
 Parti Incasso necessarie **ZB002450**



## Parte esterna monocomando lavabo a parete HARLOCK\_HC005515

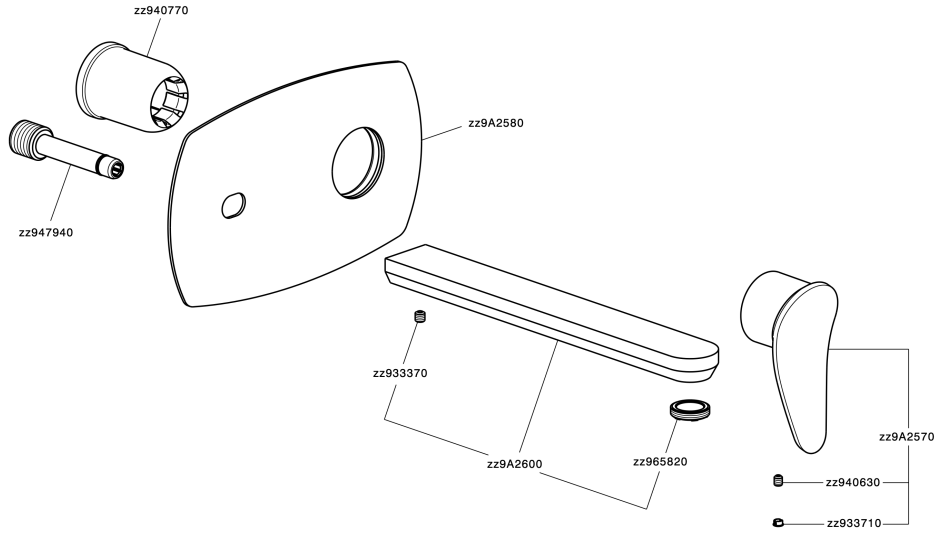

HC005515

<http://www.huberitalia.com/parte-esterna-monocomando-lavabo-a-parete-harlock-hc005515>

## Parte incasso monocomando lavabo a parete Easy-Box INCASSO\_ZB002450

MODELLO **ZB002450**

Parte incasso monocomando lavabo a parete Easy-Box, con scatola di protezione, senza parte esterna

FINITURE DISPONIBILI



CARATTERISTICHE

Installazione	<b>Incasso</b>
Ricambio Cartuccia	<b>ZZ95409000</b>
<b>Cartuccia Monocomando 35 mm</b>	
Incasso	<b>1</b>

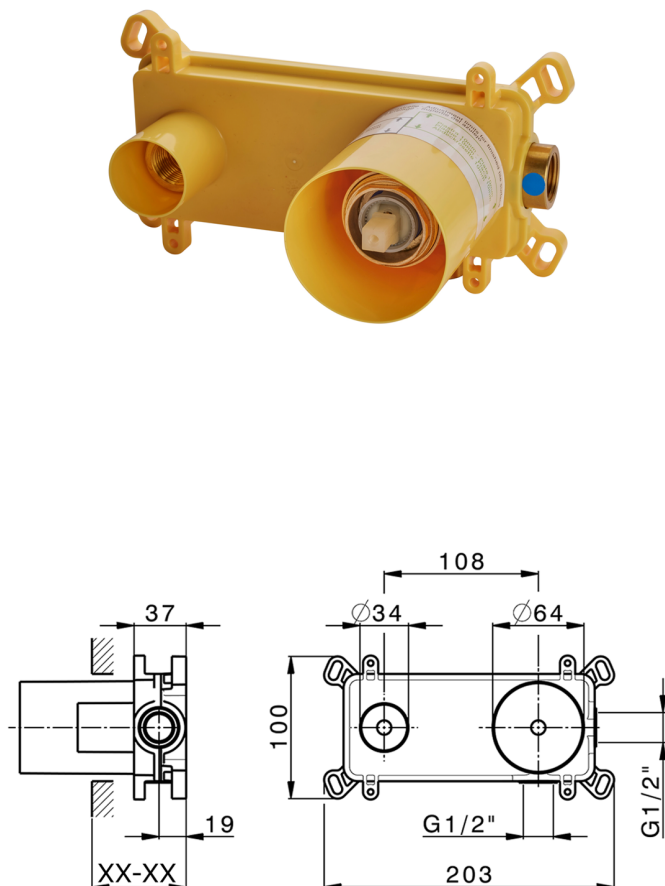

Piastra/Plate/Plaque/Platte/Placa

2-3mm: XX 56-76

10mm: XX 48-68



### EcoStop

Con il Dispositivo EcoStop l'apertura dell'acqua avviene con un punto duro al 50% circa della portata. Un fermo a metà apertura, da vincere con una leggera forza solo e soltanto quando ci sia una reale necessità di richiesta d'acqua alla massima portata. Ciò permette di consumare fino al 50% in meno di acqua.



2025-04-05