

Miscelatore monocomando vasca completo NORMA_NM000093



MODELLO **NM000093**

Miscelatore monocomando vasca completo, supporto doccia snodato murale, doccia Teti 3 getti in ABS, flex Ottone 150 cm

FINITURE DISPONIBILI



CARATTERISTICHE

Ricambio Cartuccia **ZZ94034000**

Cartuccia Monocomando 35 mm

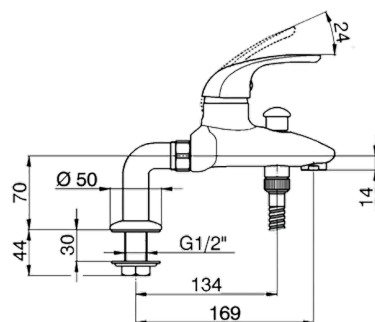
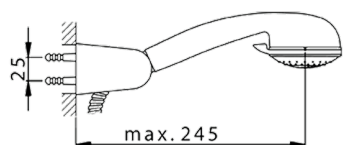

2025-04-05