

Parte esterna per singolo Push&Shower PUSH&SHOWER_PS0G6310

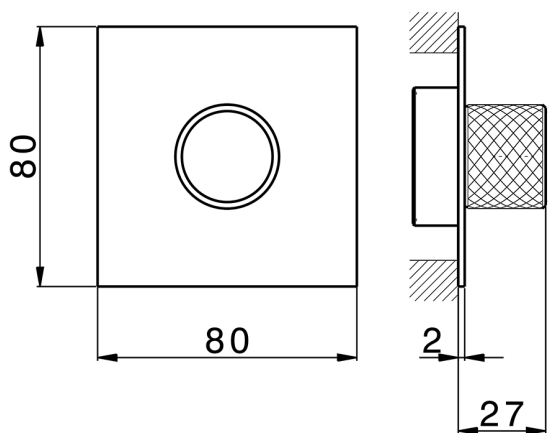

MODELLO **PS0G6310**

Parte esterna per singolo Push&Shower, pulsante con design zigrinato, piastra quadra 80x80 mm, per incasso Push&Shower

FINITURE DISPONIBILI

-  **21** 21 Cromo
-  **24** 24 Oro
-  **26** 26 Vecchio Rame
-  **2B** 2B Nichel Lucido
-  **2F** 2F Nichel Spazzolato
-  **2W** 2W Oro Spazzolato
-  **3W** 3W Brushed Black Titanium
-  **5G** 5G Oro Rosa
-  **40** 40 Nero Opaco



Termostatico

Il Termostatico Huber è il tuo personale gestore dell'acqua che ti aiuta a gestire e controllare acqua ed energia senza sprechi.

CARATTERISTICHE

Installazione **Incasso**
Parti Incasso necessarie **ZB0G6000**



Parte incasso Push&Shower INCASSO_ZB0G6000

MODELLO **ZB0G6000**

Parte incasso Push&Shower, pulsante ON/OFF completo di regolazione portata, con scatola di protezione, abbinare a parte esterna Push&Shower, senza parte esterna



FINITURE DISPONIBILI

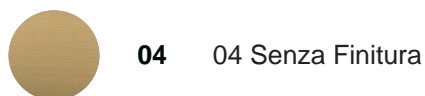

CARATTERISTICHE

Cartuccia Termostatica Argo 2 (filtro lungo)

Incasso	1
Installazione	Incasso



2025-04-01