

Parte esterna termostatico doccia incasso 1 uscita CROISSETTE_CS007280

MODELLO **CS007280**

Parte esterna termostatico doccia incasso 1 uscita, rubinetto d'arresto, senza parte incasso, per art. ZB007281-ZB007341

FINITURE DISPONIBILI

-  **21** 21 Cromo
-  **27** 27 Vecchio Bronzo
-  **2G** 2G Oro Antico
-  **2W** 2W Oro Spazzolato

CARATTERISTICHE

Installazione **Incasso**
 Parti Incasso necessarie **ZB007341**
ZB007281

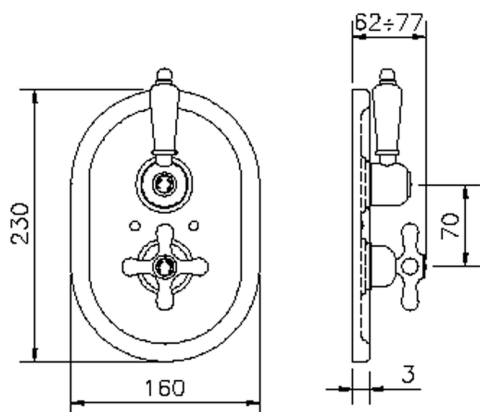

Termostatico

Il Termostatico Huber è il tuo personale gestore dell'acqua che ti aiuta a gestire e controllare acqua ed energia senza sprechi.



Parte esterna termostatico doccia incasso 1 uscita CROISSETTE_CS007280

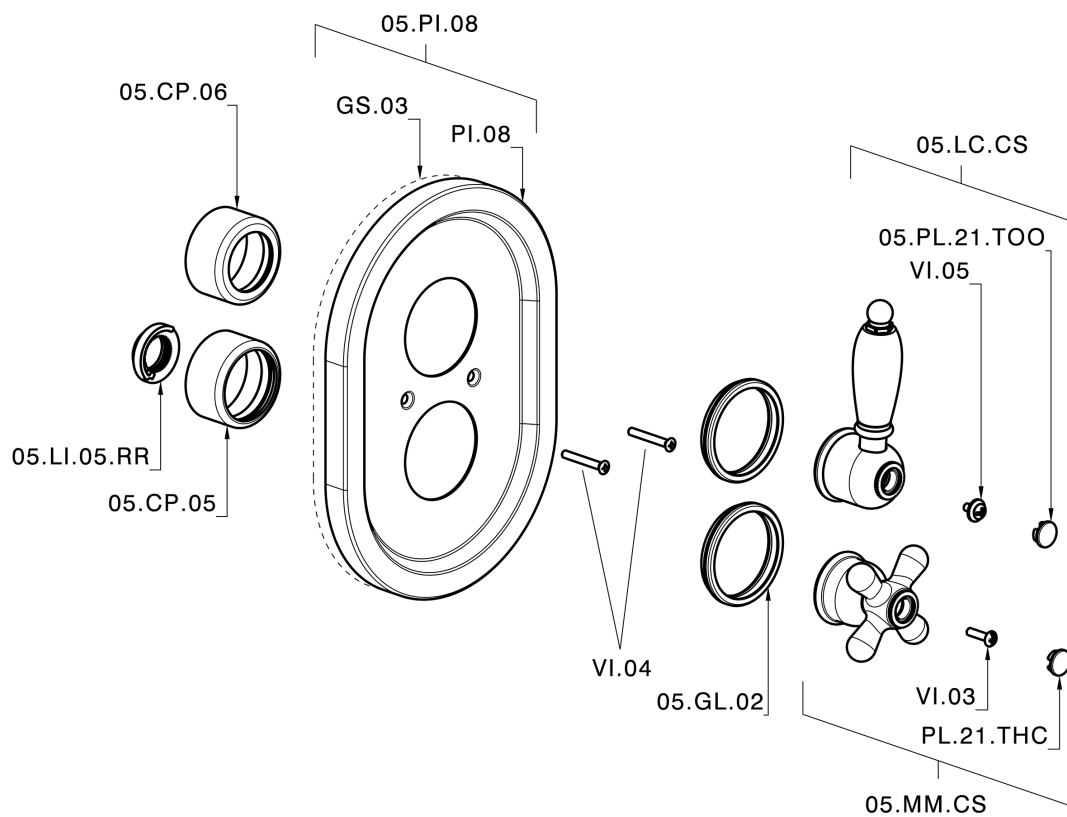

CS007280

<http://www.huberitalia.com/parte-esterna-termostatico-doccia-incasso-1-uscita-croisette-cs007280>

Parte incasso termostatico doccia 1 uscita INCASSO_ZB007341

MODELLO **ZB007341**

Parte incasso termostatico doccia 1 uscita, rubinetto d'arresto con uscita 3/4", senza parte esterna

FINITURE DISPONIBILI



04 04 Senza Finitura



CARATTERISTICHE

Installazione	Incasso
Ricambio Cartuccia	23.51A.HF
Cartuccia Termostatica HF	
Incasso	1

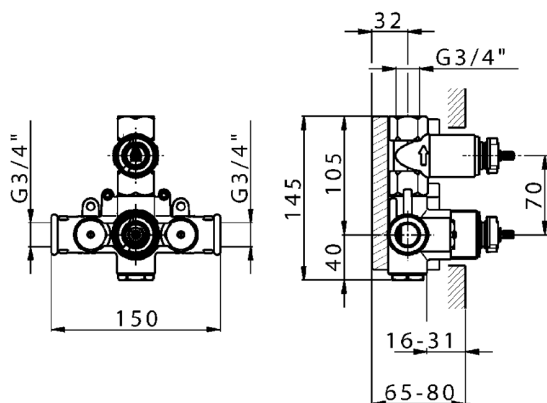

Termostatico

Il Termostatico Huber è il tuo personale gestore dell'acqua che ti aiuta a gestire e controllare acqua ed energia senza sprechi.



Parte incasso termostatico doccia 1 uscita INCASSO_ZB007281

MODELLO **ZB007281**

Parte incasso termostatico doccia 1 uscita, rubinetto d'arresto con uscita 1/2", senza parte esterna

FINITURE DISPONIBILI



04 04 Senza Finitura

CARATTERISTICHE

Installazione	Incasso
Ricambio Cartuccia	24.04A.PP
Cartuccia Termostatica Plus P 8X20	
Incasso	1



Termostatico

Il Termostatico Huber è il tuo personale gestore dell'acqua che ti aiuta a gestire e controllare acqua ed energia senza sprechi.



2025-04-04