

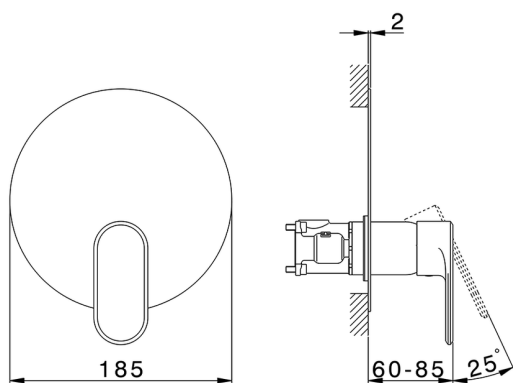





## Completo Monocomando per One-Box LEVITY\_LY0BM010



MODELLO **LY0BM010**

Completo Monocomando per One-Box, 1 uscita, profondità minima di installazione 67 mm, senza parte incasso, per art. ZB00B030-ZB00B031

### FINITURE DISPONIBILI

-  **21** 21 Cromo
-  **2B** 2B Nichel Lucido
-  **2F** 2F Nichel Spazzolato
-  **40** 40 Nero Opaco
-  **4Q** 4Q Bianco Opaco

### CARATTERISTICHE

Ricambio Cartuccia **ZZ97179000**

**Cartuccia Monocomando 35 mm**

Installazione **Incasso**

Parti Incasso necessarie **ZB00B031**

**ZB00B030**



## Completo Monocomando per One-Box LEVITY\_LY0BM010

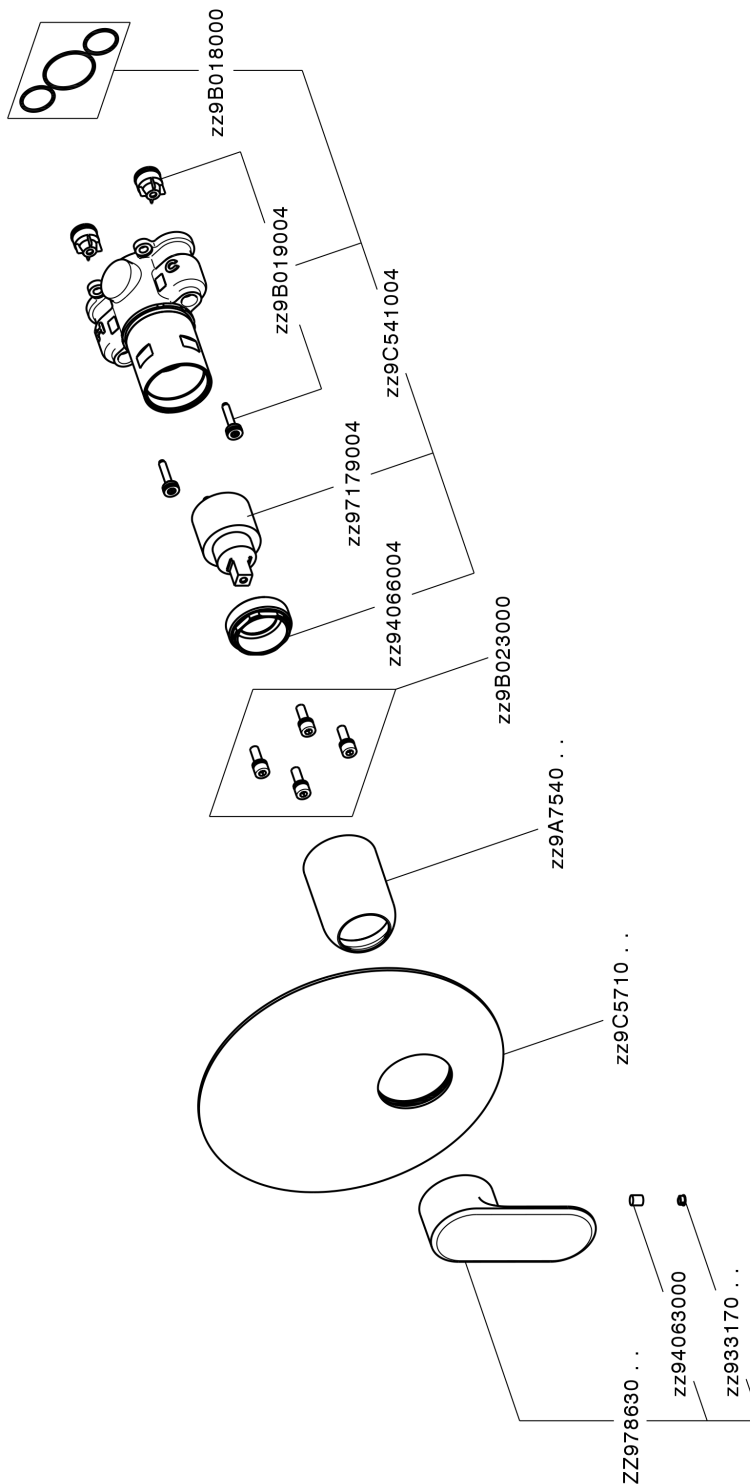

LY0BM010

<http://www.huberitalia.com/completo-monocomando-per-one-box-levity-ly0bm010>

## One-Box Universale per incasso ONE BOX\_ZB00B031



MODELLO **ZB00B031**

One-Box Universale per incasso, per termostatico o monocomando 1 o 2 o 3 uscite, senza parte esterna, con silenziosi, con guarnizione per sigillatura

FINITURE DISPONIBILI



**04** 04 Senza Finitura

CARATTERISTICHE

Incasso **1**  
Installazione **Incasso**



### Termostatico

Il Termostatico Huber è il tuo personale gestore dell'acqua che ti aiuta a gestire e controllare acqua ed energia senza sprechi.



## One-Box Universale per incasso ONE BOX\_ZB00B030

MODELLO **ZB00B030**

One-Box Universale per incasso, per termostatico o monocomando 1 o 2 o 3 uscite, senza parte esterna, senza silenziosi, con guarnizione per sigillatura

FINITURE DISPONIBILI

 **04** 04 Senza Finitura

CARATTERISTICHE

Incasso **1**  
 Installazione **Incasso**



### Termostatico

Il Termostatico Huber è il tuo personale gestore dell'acqua che ti aiuta a gestire e controllare acqua ed energia senza sprechi.



2025-04-04