

Colonna vasca termostatica 3 funzioni CROISETTE_592.CS21H.

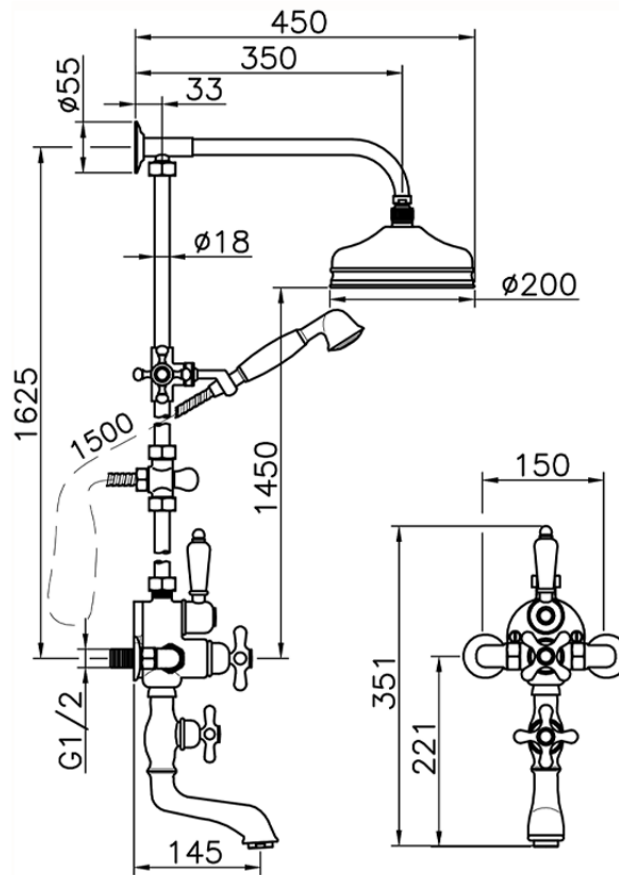

592.CS21H.

<http://www.huberitalia.com/colonna-vasca-termostatica-3-funzioni-croisette-592-cs21h>

2024-12-22