

Parte esterna monocomando lavabo a pavimento NUOVA KIRUNA_K2014510

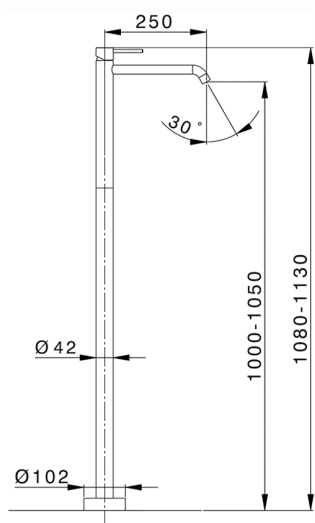

MODELLO **K2014510**

Parte esterna monocomando lavabo a pavimento, senza parte incasso, per art. ZB004510

FINITURE DISPONIBILI

-  **21** 21 Cromo
-  **26** 26 Vecchio Rame
-  **2F** 2F Nichel Spazzolato
-  **2W** 2W Oro Spazzolato
-  **40** 40 Nero Opaco
-  **4Q** 4Q Bianco Opaco

CARATTERISTICHE

Ricambio Cartuccia **ZZ99672000**

Cartuccia Monocomando 35 mm

Installazione **Incasso**

Parti Incasso necessarie **ZB004510**



EcoStop

Con il Dispositivo EcoStop l'apertura dell'acqua avviene con un punto duro al 50% circa della portata. Un fermo a metà apertura, da vincere con una leggera forza solo e soltanto quando ci sia una reale necessità di richiesta d'acqua alla massima portata. Ciò permette di consumare fino al 50% in meno di acqua.



Parte incasso monocomando free-standing INCASSO_ZB004510

MODELLO **ZB004510**

Parte incasso a pavimento, per monocomando free-standing

FINITURE DISPONIBILI



04 04 Senza Finitura

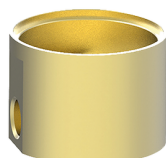

CARATTERISTICHE

Installazione	Incasso
Incasso	1

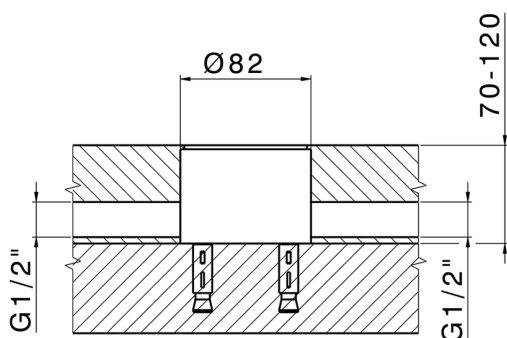

2024-09-20