

Parte esterna lavabo a parete NUOVA KIRUNA_K2013512

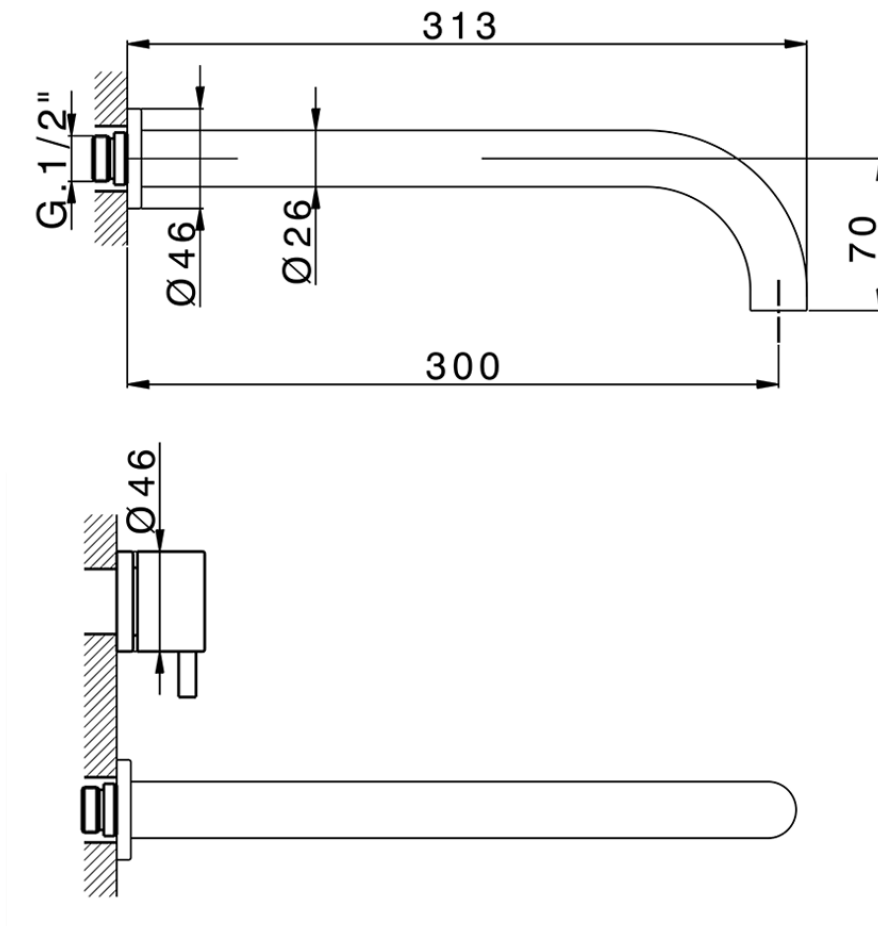

K2013512

<http://www.huberitalia.com/parte-esterna-lavabo-a-parete-nuova-kiruna-k2013512>



| Serie's code | Size XX |
|--------------|---------|
| CX 1351 | 20-35 |
| CF 1351 | 20-35 |
| CX 0331 | 20-35 |
| CF 0331 | 20-35 |
| CX 0200 | 20-35 |
| CF 0200 | 20-35 |
| BA 1351 | 20-35 |
| GS 1351 | 20-35 |
| GL 1351 | 20-35 |
| MN 1351 | 20-35 |
| LN 1351 | 20-35 |
| LV 1351 | 33-48 |
| LY 1351 | 33-48 |
| CU 1351 | 33-48 |
| SM 1351 | 30-45 |
| AA 1351 | 10-30 |
| AC 1351 | 10-30 |
| AR 1351 | 15-25 |
| PZ 1351 | 10-30 |
| RG 1351 | 10-30 |
| TS 1351 | 10-30 |
| VT 1351 | 10-30 |
| CS 1351 | 10-30 |
| WA 1351 | 45-68 |
| X1 1351 | 33-45 |
| X2 1351 | 33-45 |
| X3 1351 | 33-45 |
| X4 1351 | 33-45 |
| X5 1351 | 33-45 |
| RI 1351 | 20-35 |
| RM 1351 | 20-35 |

Limiti di tolleranza superficie piastrelle
 Adjustment limits for finished tile surface
 Limites de tolérance surface carrelage
 Fliesenoberfläche
 Superficie del azulejo

ZB033511

<http://www.huberitalia.com/parte-incasso-lavabo-a-parete-incasso-zb033511>

2025-04-04