

Parte esterna termostatico doccia incasso CROISSETTE_CS007200

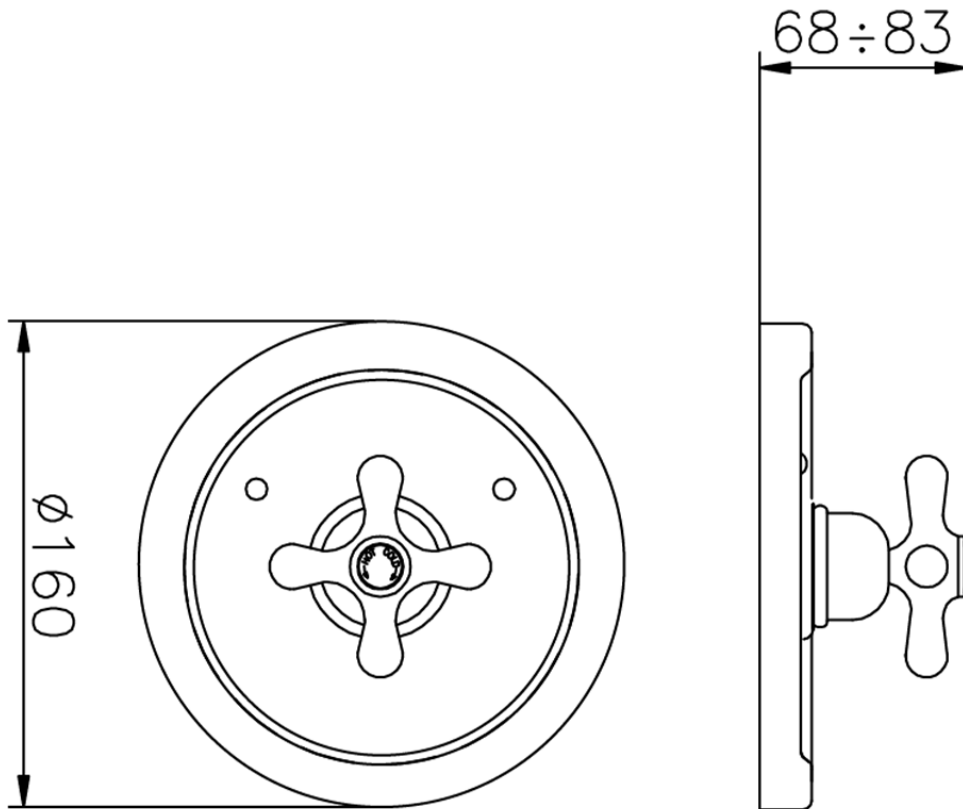

CS007200

<http://www.huberitalia.com/parte-esterna-termostatico-doccia-incasso-croisette-cs007200>



Piastra/Plate/Plaque/Platte/Placa

2-3mm: XX 25-40 YY 76-91

10mm: XX 16-31 YY 65-80

ZB007221

<http://www.huberitalia.com/parte-incasso-termostatico-doccia-3-4-incasso-zb007221>



ZB007201

<http://www.huberitalia.com/parte-incasso-termostatico-doccia-1-2-incasso-zb007201>

2025-02-05