

Miscelatore termostatico vasca CROISSETTE\_CST27010

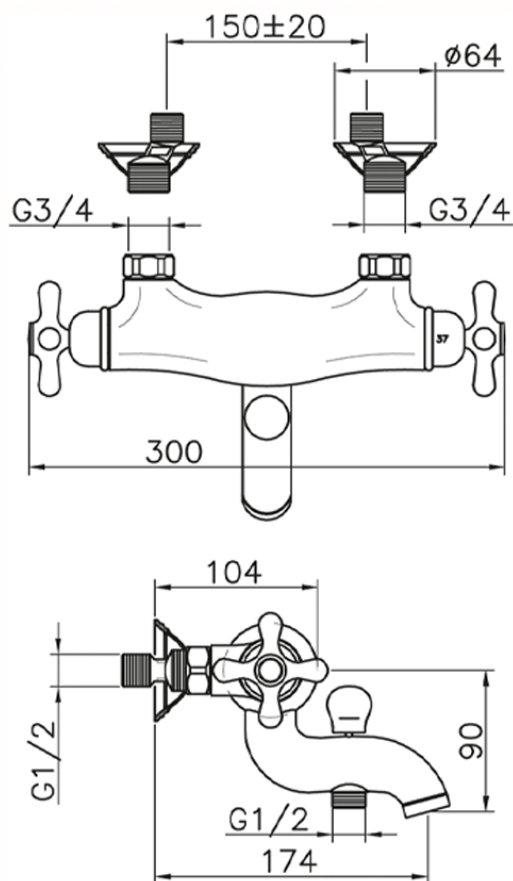

CST27010

<http://www.huberitalia.com/miscelatore-termostatico-vasca-croisette-cst27010>

2025-04-04