

Miscelatore termostatico bidet CROISSETTE_CST56010

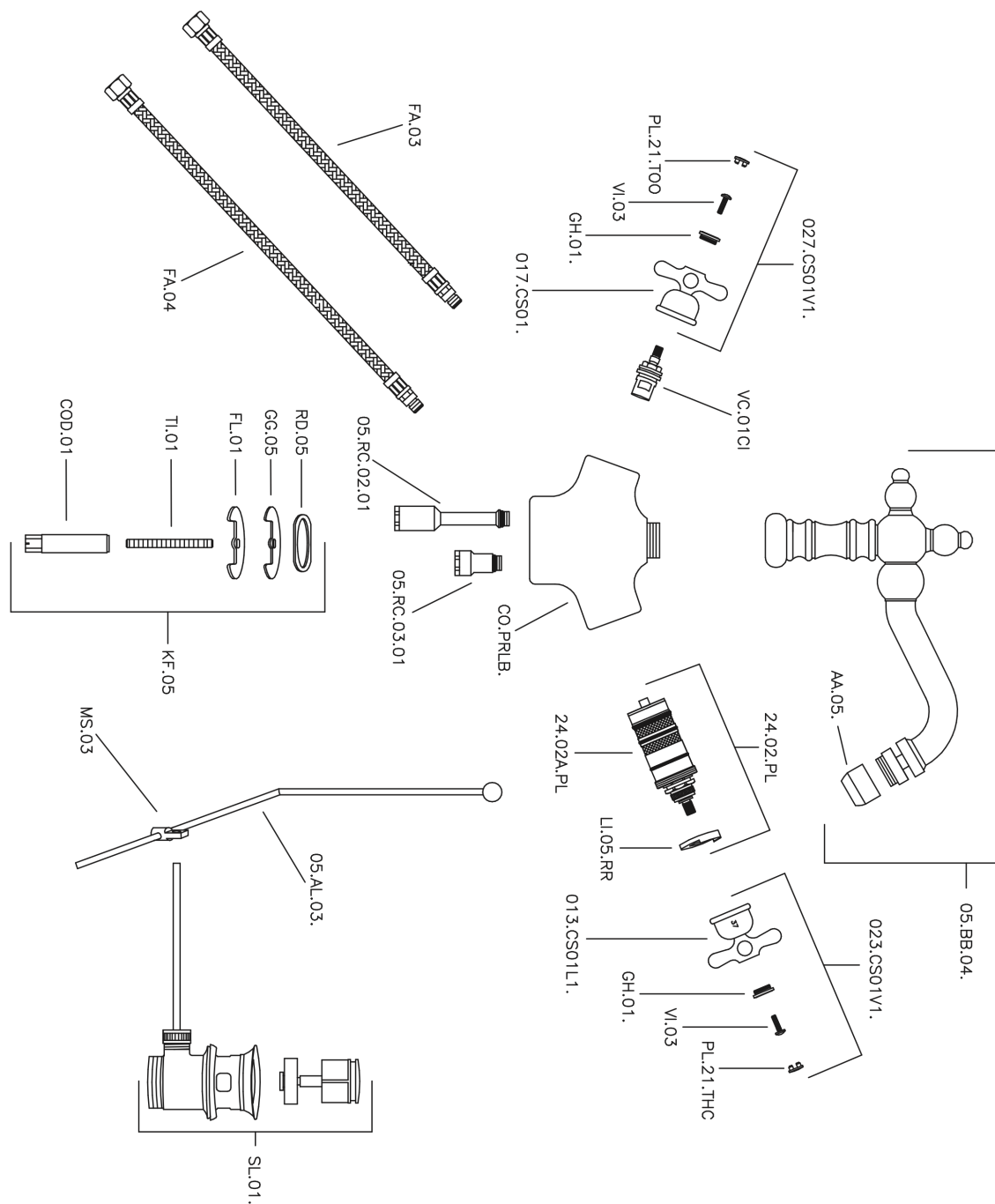

CST56010

<http://www.huberitalia.com/miscelatore-termostatico-bidet-croisette-cst56010>

2025-04-04