

Bocca di erogazione COMPLEMENTI_ZB002620

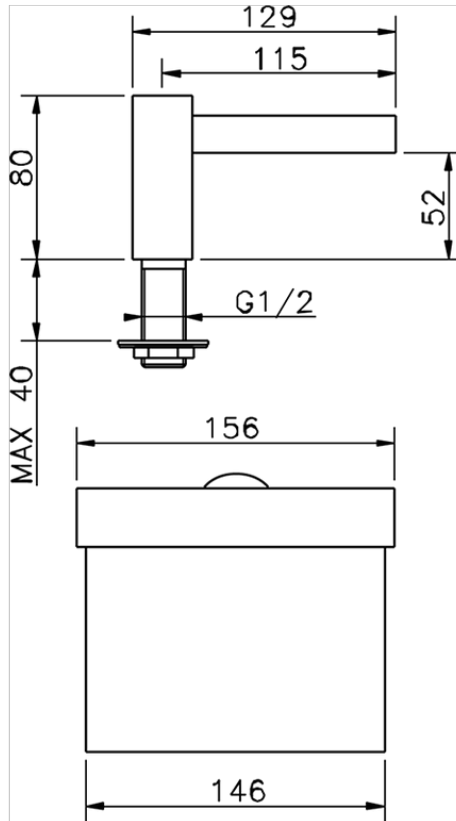

ZB002620

<http://www.huberitalia.com/bocca-di-erogazione-complementi-zb002620>

2025-04-03