

Miscelatore monocomando lavello COLLETTIVITÀ_CL300580

MODELLO **CL300580**

Miscelatore monocomando lavello, bocca girevole, leva clinica, flex inox G.3/8"

FINITURE DISPONIBILI



21 21 Cromo

CARATTERISTICHE

Ricambio Cartuccia **ZZ94035000**

Cartuccia Monocomando 35 mm

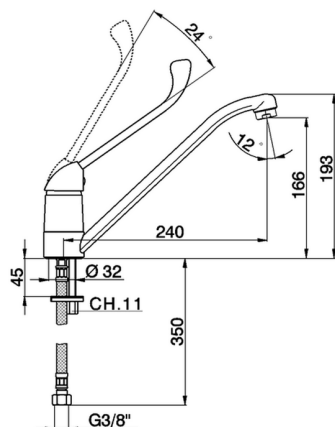

2025-04-04