

### 3-REGOLAZIONE DELLA CARTUCCIA CARTRIDGE REGULATION

MASSIMA PORTATA  
MAXIMUM FLOW

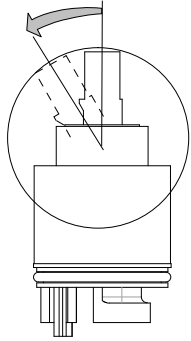

RIDUZIONE PORTATA  
REDUCING FLOW

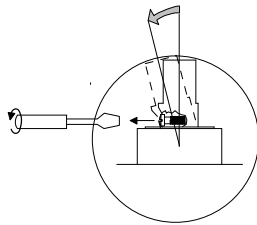

MAX. FREDDA  
MAX. COOL

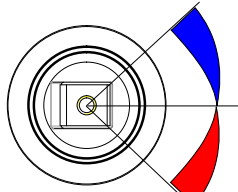

MAX. CALDA  
MAX. HOT

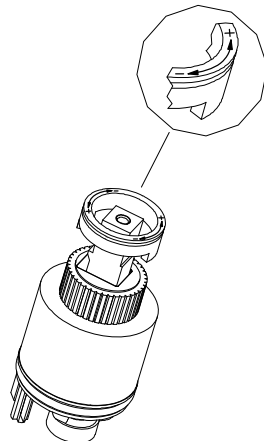

### 4-SOSTITUZIONE DELLA CARTUCCIA REPLACEMENT OF CARTRIDGE

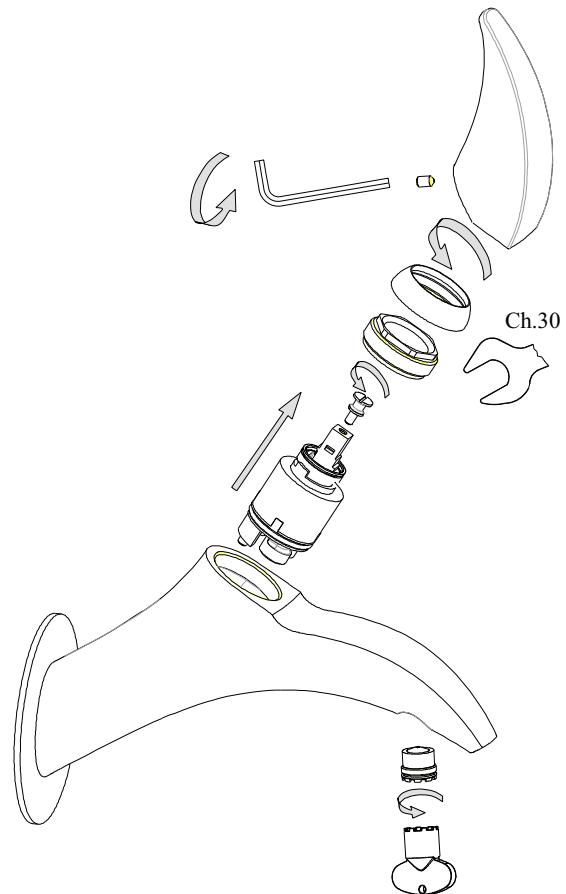

### 5- PULIZIA CLEANING

- I** - Per la pulizia quotidiana del vostro miscelatore usare unicamente acqua e sapone e asciugare con un panno morbido.  
- Non usare altri detersivi o abrasivi che potrebbero danneggiare o deteriorare la superficie cromata del miscelatore.
- GB** - For the daily cleaning of your mixer, you must use water and soap only and you have to wipe it  
With a soft cloth.  
- Do not use any other abrasive cleanser which can damage the surface of the mixer.

### 6- CONDIZIONI DI LAVORO JOB CONDITIONS

- I** - Pressione Min. di funzionamento 1 Bar  
- Pressione Max. di funzionamento 5 Bar  
- Pressione di funzionamento raccomandata 2÷4 Bar  
- Temperatura Max. acqua calda 80° C  
- Temperatura acqua calda raccomandata 60° C  
- Per pressioni superiori a 5 Bar installare un riduttore di pressione.
- GB** - Minimal pressure of operation 1 Bar  
- Maximal pressure of operation 5 Bar  
- Pressure of operation registered letter 2÷4 Bar  
- Temperature maximum hot water 80° C  
- Temperature warm water registered letter 60° C  
- For advanced pressures to 5 Bars to install a pressure reducer

**ICON**

MISCELATORE LAVABO INCASSO A MURO  
WALL MOUNTED CONCEALED BASIN MIXER

**Huber**  
AQUA EMOTIONS

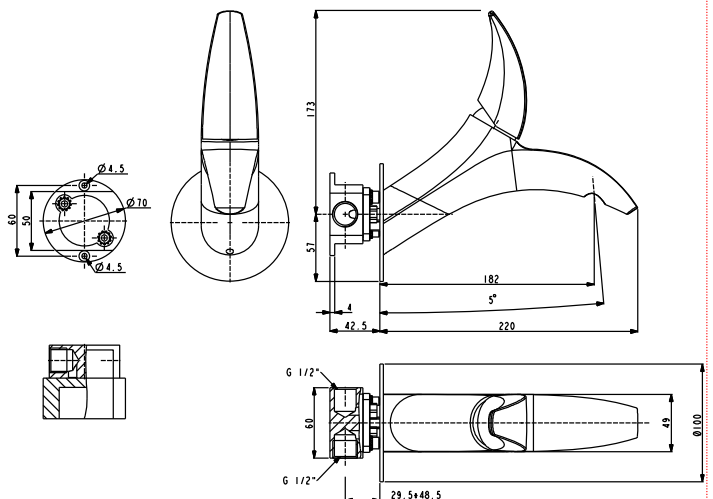

**Huber**  
AQUA EMOTIONS

Via Brughiere,50  
Fax.+39.0322.967797  
I- 28017 San Maurizio No  
e-mail :huber@huber-on-line.com  
Tel.+39.0322.967783

IS.345

**1- INSTALLAZIONE :  
INSTALLATION :**

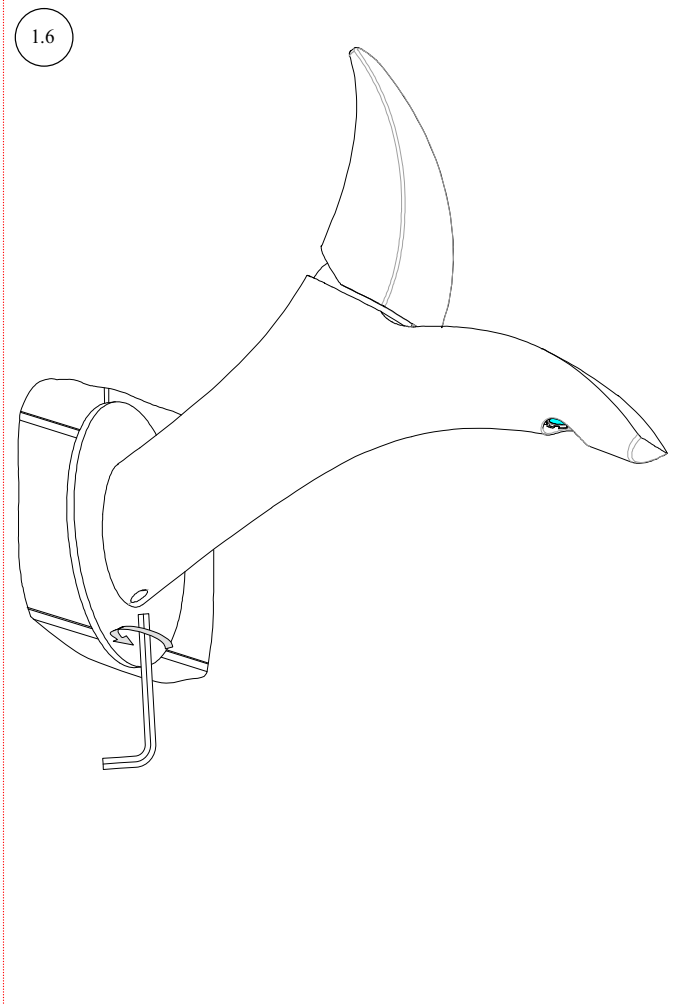
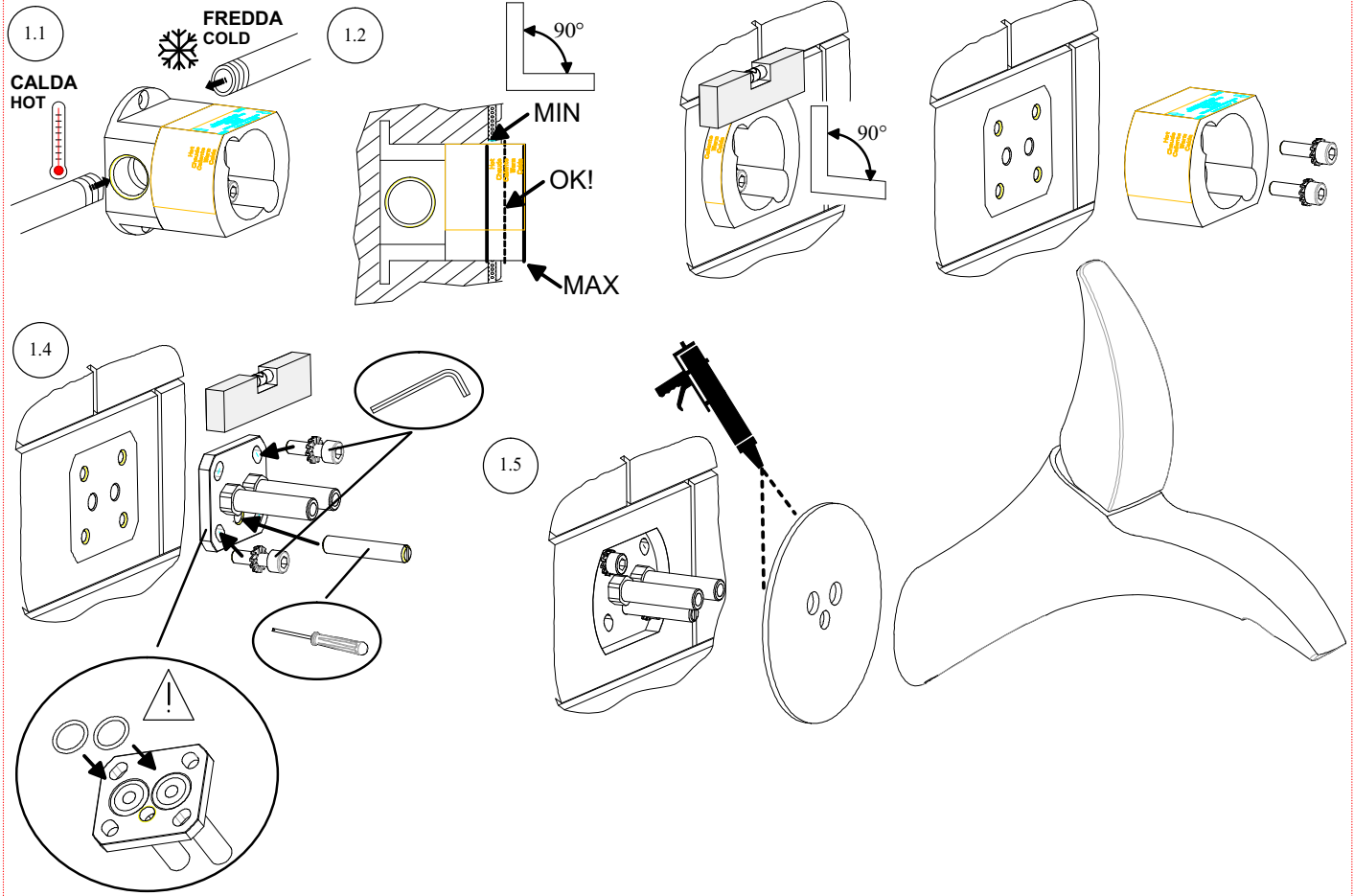

**2- FUNZIONAMENTO :  
OPERATION :**

