

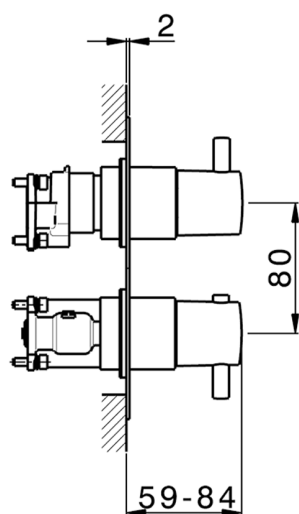

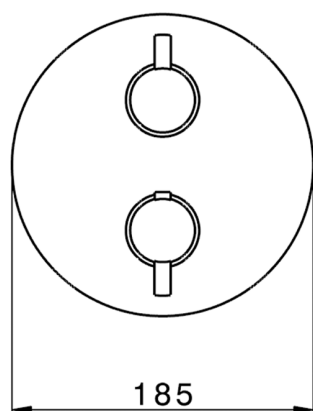

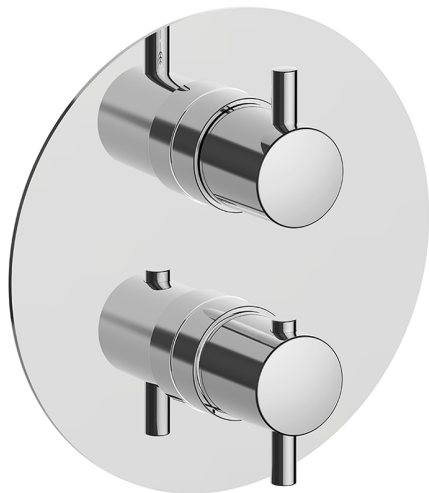

## Completo Termostatico per One-Box ONE BOX\_MT0BT030



MODELLO **MT0BT030**

Completo Termostatico per One-Box, con deviasstop 1-2-3 uscite, profondità minima di installazione 67 mm, senza parte incasso, per art. ZB00B030-ZB00B031

### FINITURE DISPONIBILI

-  **21** 21 Cromo
-  **26** 26 Vecchio Rame
-  **2F** 2F Nichel Spazzolato
-  **2W** 2W Oro Spazzolato
-  **40** 40 Nero Opaco
-  **4Q** 4Q Bianco Opaco

### CARATTERISTICHE

Ricambio Cartuccia **24.04A.PP**  
 Installazione **Incasso**  
 Parti Incasso necessarie **ZB00B031**  
**ZB00B030**



#### DeviaStop

La tecnologia Devia Stop di Huber consente con un semplice movimento rotativo di gestire la portata dell'acqua e di scegliere la modalità d'erogazione (soffione, doccia a mano).



#### Termostatico

Il Termostatico Huber è il tuo personale gestore dell'acqua che ti aiuta a gestire e controllare acqua ed energia senza sprechi.



## One-Box Universale per incasso ONE BOX\_ZB00B031



MODELLO **ZB00B031**

One-Box Universale per incasso, per termostatico o monocomando 1 o 2 o 3 uscite, senza parte esterna, con silenziosi, con guarnizione per sigillatura

FINITURE DISPONIBILI

 **04** 04 Senza Finitura

CARATTERISTICHE

Incasso **1**  
Installazione **Incasso**



### Termostatico

Il Termostatico Huber è il tuo personale gestore dell'acqua che ti aiuta a gestire e controllare acqua ed energia senza sprechi.



## One-Box Universale per incasso ONE BOX\_ZB00B030

MODELLO **ZB00B030**

One-Box Universale per incasso, per termostatico o monocomando 1 o 2 o 3 uscite, senza parte esterna, senza silenzianti, con guarnizione per sigillatura

FINITURE DISPONIBILI

 **04** 04 Senza Finitura

CARATTERISTICHE

Incasso **1**  
 Installazione **Incasso**



### Termostatico

Il Termostatico Huber è il tuo personale gestore dell'acqua che ti aiuta a gestire e controllare acqua ed energia senza sprechi.



2025-01-04