





Parte esterna termostatico doccia incasso 3 uscite THERMO_NE018200



MODELLO **NE018200**

Parte esterna termostatico incasso 3 uscite, con deviasstop 3 uscite, senza parte incasso, per art. ZB018201

FINITURE DISPONIBILI

-  **21** 21 Cromo
-  **2F** 2F Nichel Spazzolato
-  **40** 40 Nero Opaco
-  **4Q** 4Q Bianco Opaco

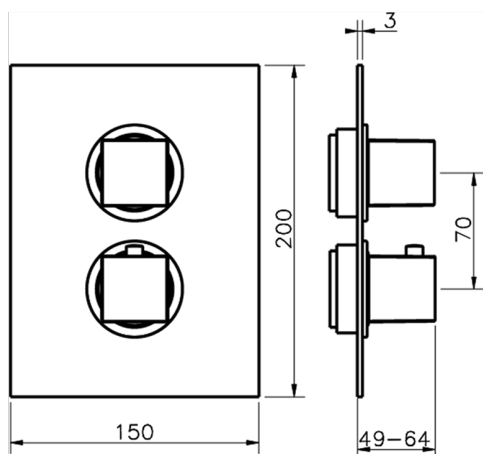

CARATTERISTICHE

Installazione **Incasso**
 Parti Incasso necessarie **ZB018201**



Termostatico

Il Termostatico Huber è il tuo personale gestore dell'acqua che ti aiuta a gestire e controllare acqua ed energia senza sprechi.



Parte incasso termostatico doccia 3 uscite INCASSO_ZB018201

MODELLO **ZB018201**

Parte incasso termostatico 3 uscite, con devia stop 3 uscite, senza parte esterna

FINITURE DISPONIBILI



04 04 Senza Finitura



CARATTERISTICHE

Installazione	Incasso
Ricambio Cartuccia	24.04A.PP
Cartuccia Termostatica Plus P 8X20	
Incasso	1



Piastra/Plate/Plaque/Platte/Placa
 2-3mm: XX 25-40 YY 76-91
 10 mm: XX 16-31 YY 65-80



DeviaStop

La tecnologia Devia Stop di Huber consente con un semplice movimento rotativo di gestire la portata dell'acqua e di scegliere la modalità d'erogazione (soffione, doccia a mano).



Termostatico

Il Termostatico Huber è il tuo personale gestore dell'acqua che ti aiuta a gestire e controllare acqua ed energia senza sprechi.



2024-11-21