



Parte esterna termostatico doccia incasso 2 uscite CHRONOS_CR019140

MODELLO **CR019140**

Parte esterna termostatico doccia incasso 2 uscite, con deviasop 2 uscite, senza parte incasso, per art. ZB019140



FINITURE DISPONIBILI

-  **21** 21 Cromo
-  **2F** 2F Nichel Spazzolato
-  **2Q** 2Q Black Titanium

CARATTERISTICHE

Installazione **Incasso**
 Parti Incasso necessarie **ZB019140**

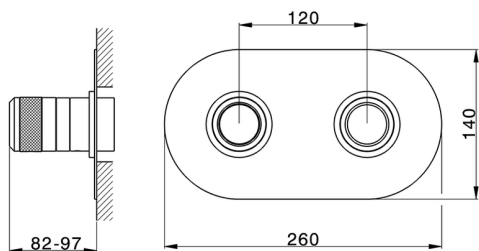

Termostatico

Il Termostatico Huber è il tuo personale gestore dell'acqua che ti aiuta a gestire e controllare acqua ed energia senza sprechi.



Parte incasso termostatico doccia 2 uscite INCASSO_ZB019140

MODELLO **ZB019140**

Parte incasso termostatico doccia 2 uscite, senza parte esterna

FINITURE DISPONIBILI



04 04 Senza Finitura



CARATTERISTICHE

Installazione	Incasso
Ricambio Cartuccia	24.04A.PP
	Cartuccia Termostatica Plus P 8X20
Incasso	1

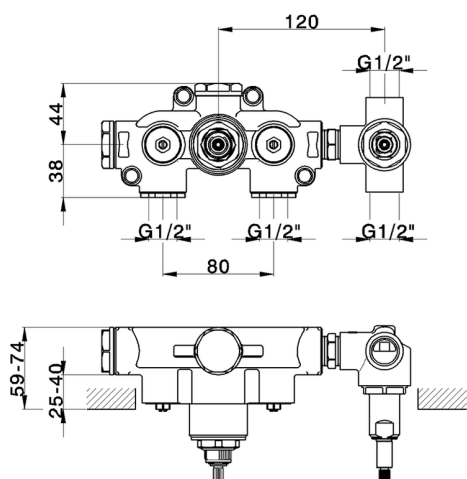

Termostatico

Il Termostatico Huber è il tuo personale gestore dell'acqua che ti aiuta a gestire e controllare acqua ed energia senza sprechi.



2025-01-02