

## Parte esterna termostatico incasso PUSH&SHOWER\_PS0G1020

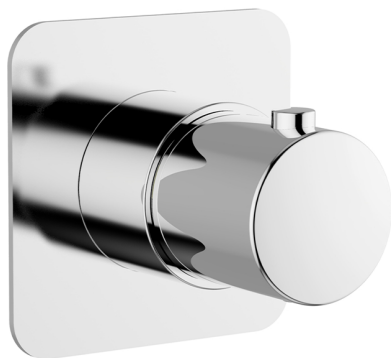

MODELLO **PS0G1020**

Parte esterna termostatico incasso, senza parte incasso, piastra raggiata 80x80 mm, per incasso thermo con scatola di protezione

### FINITURE DISPONIBILI

-  **21** 21 Cromo
-  **24** 24 Oro
-  **26** 26 Vecchio Rame
-  **2B** 2B Nichel Lucido
-  **2F** 2F Nichel Spazzolato
-  **2W** 2W Oro Spazzolato
-  **3W** 3W Brushed Black Titanium
-  **5G** 5G Oro Rosa
-  **40** 40 Nero Opaco

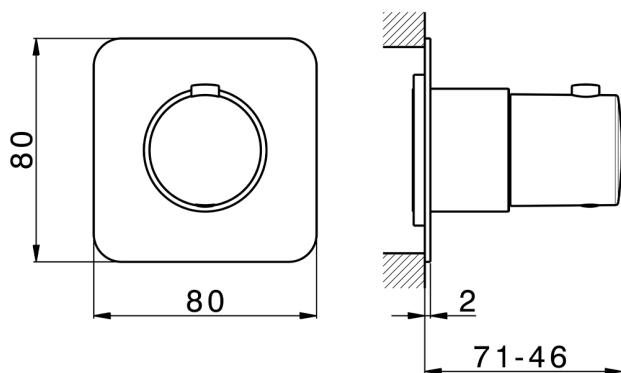

### Termostatico

Il Termostatico Huber è il tuo personale gestore dell'acqua che ti aiuta a gestire e controllare acqua ed energia senza sprechi.

### CARATTERISTICHE

Installazione **Incasso**  
Parti Incasso necessarie **ZB0G1000**



## Parte incasso termostatico INCASSO\_ZB0G1000

MODELLO **ZB0G1000**

Parte incasso termostatico, senza rubinetto d'arresto, con scatola di protezione, abbinare a parte esterna Thermo, senza parte esterna



FINITURE DISPONIBILI

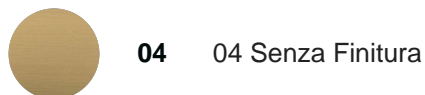

CARATTERISTICHE

Ricambio Cartuccia **22.04A.AR - ZZ97279004**

**Cartuccia Termostatica Argo 2 (filtro lungo)**

Incasso **1**

Installazione **Incasso**

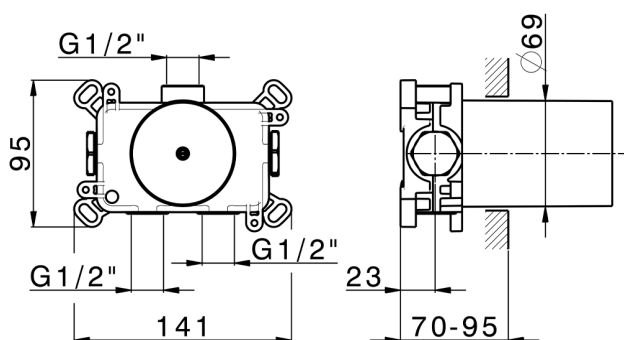

### Termostatico

Il Termostatico Huber è il tuo personale gestore dell'acqua che ti aiuta a gestire e controllare acqua ed energia senza sprechi.



2025-03-12