



Parte esterna termostatico doccia incasso 2 uscite CHRONOS_CR019100



MODELLO **CR019100**

Parte esterna termostatico doccia incasso 2 uscite, con deviasstop 2 uscite, senza parte incasso, per art. ZB019100

FINITURE DISPONIBILI

-  **21** 21 Cromo
-  **2F** 2F Nichel Spazzolato
-  **2Q** 2Q Black Titanium

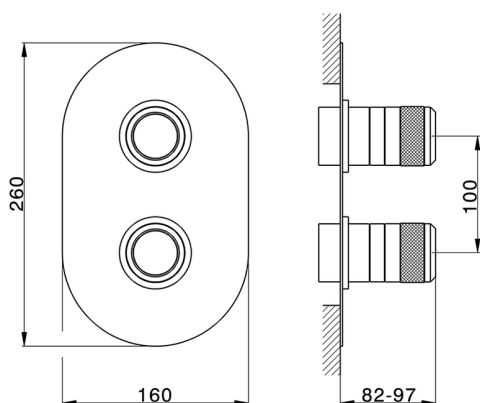

CARATTERISTICHE

Installazione **Incasso**
 Parti Incasso necessarie **ZB019100**



Termostatico

Il Termostatico Huber è il tuo personale gestore dell'acqua che ti aiuta a gestire e controllare acqua ed energia senza sprechi.



Parte incasso termostatico doccia 2 uscite INCASSO_ZB019100

MODELLO **ZB019100**

Parte incasso termostatico doccia 2 uscite, con deviasp 2 uscite 1/2", senza parte esterna

FINITURE DISPONIBILI



04 04 Senza Finitura



CARATTERISTICHE

Installazione	Incasso
Ricambio Cartuccia	24.04A.PP
Cartuccia Termostatica Plus P 8X20	
Incasso	1

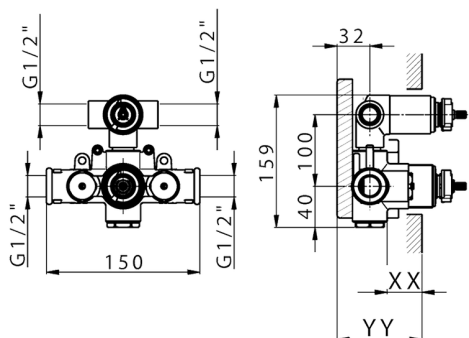

Piastra/Plate/Plaque/Platte/Placa
 2-3mm: XX 25-40 YY 76-91
 10mm: XX 21-34 YY 70-83



Termostatico

Il Termostatico Huber è il tuo personale gestore dell'acqua che ti aiuta a gestire e controllare acqua ed energia senza sprechi.



2025-01-05