

## Parte esterna termostatico doccia incasso 3 uscite HARLOCK\_HC018200

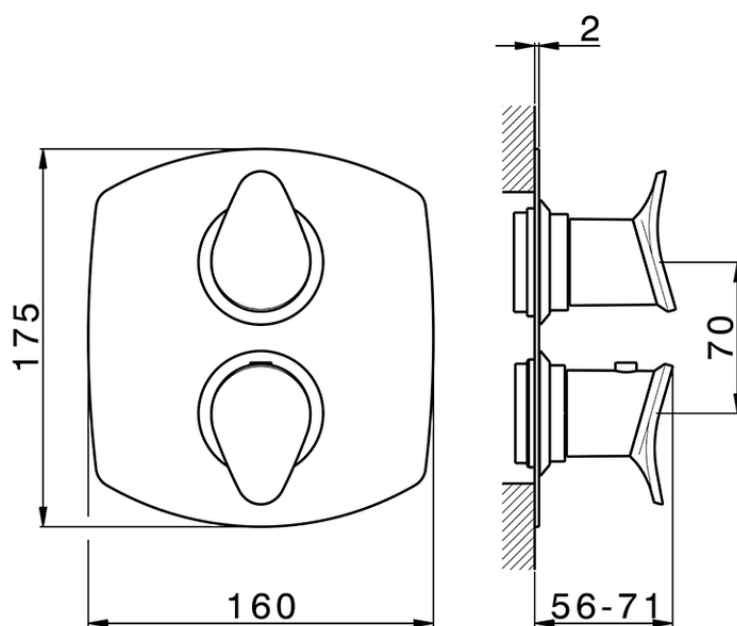

HC018200

<https://huberitalia.com/parte-esterna-termostatico-doccia-incasso-3-uscite-harlock-hc018200>



Piastra/Plate/Plaque/Platte/Placa

2-3mm: XX 25-40 YY 76-91

10 mm: XX 16-31 YY 65-80

ZB018200

<https://huberitalia.com/parte-incasso-termostatico-doccia-3-uscite-incasso-zb018200>

2024-11-23