

Parte esterna termostatico doccia incasso 2 uscite THERMO_SU018100

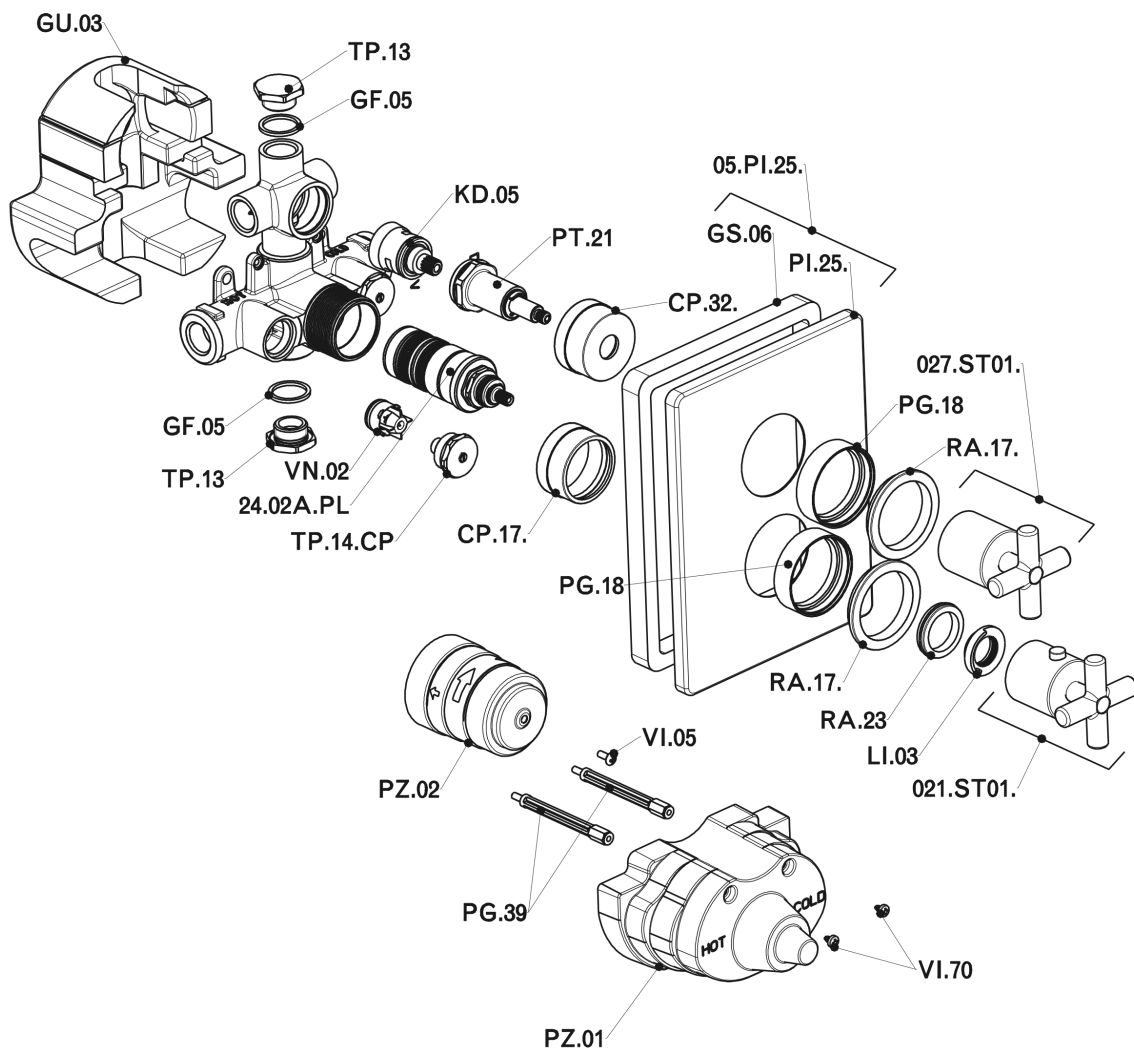

SU018100

<https://huberitalia.com/parte-esterna-termostatico-doccia-incasso-2-uscite-thermo-su018100>

Parte incasso termostatico doccia 2 uscite INCASSO_ZB018101

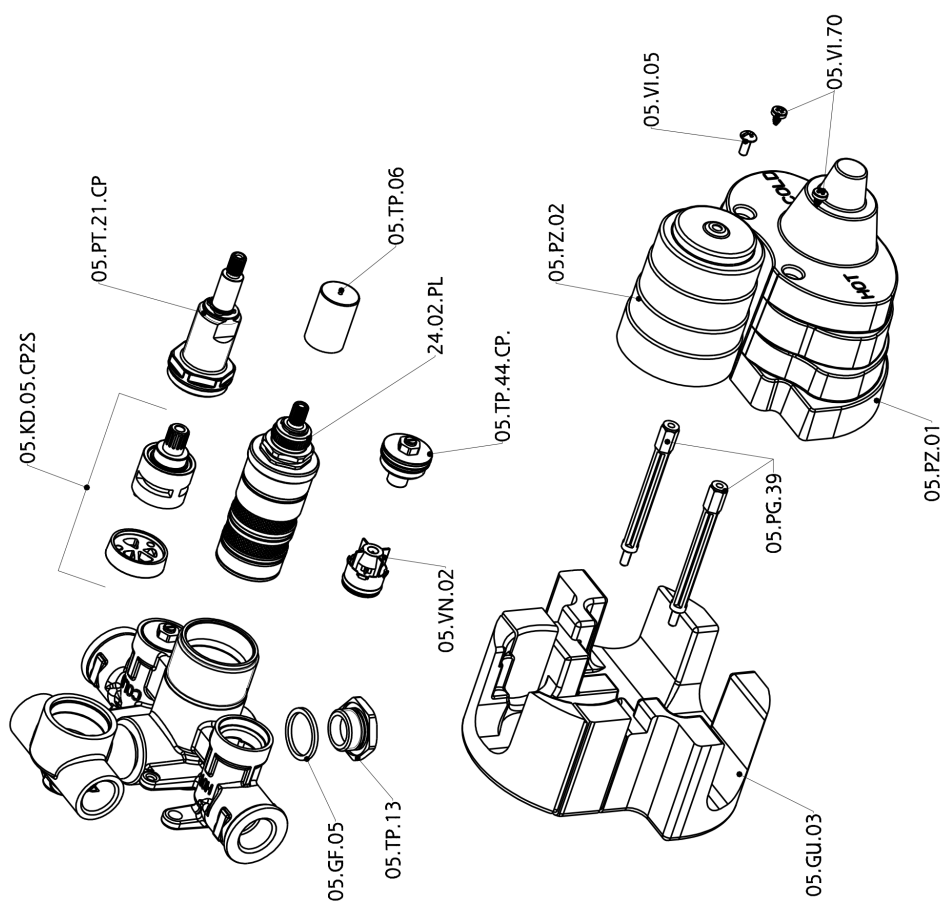

ZB018101

<https://huberitalia.com/parte-incasso-termostatico-doccia-2-uscite-incasso-zb018101>

2024-12-04