

Parte esterna termo doccia incasso 2 funzioni NUOVA KIRUNA_K201R200

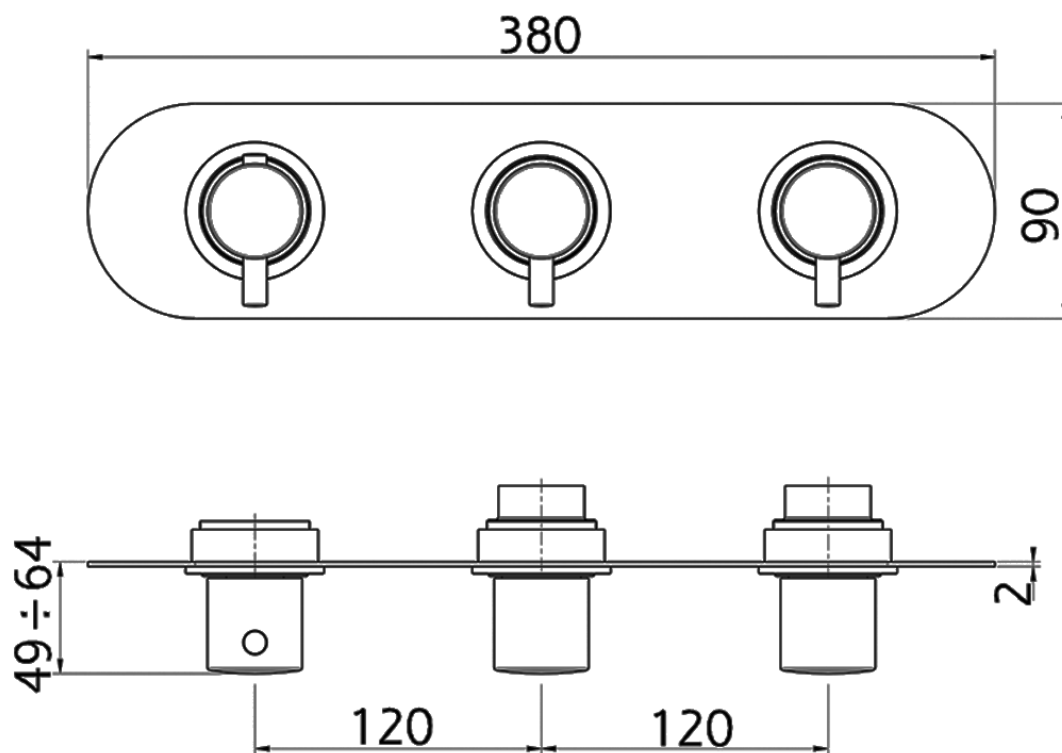

K201R200

<https://huberitalia.com/parte-esterna-termo-doccia-incasso-2-funzioni-nuova-kiruna-k201r200>

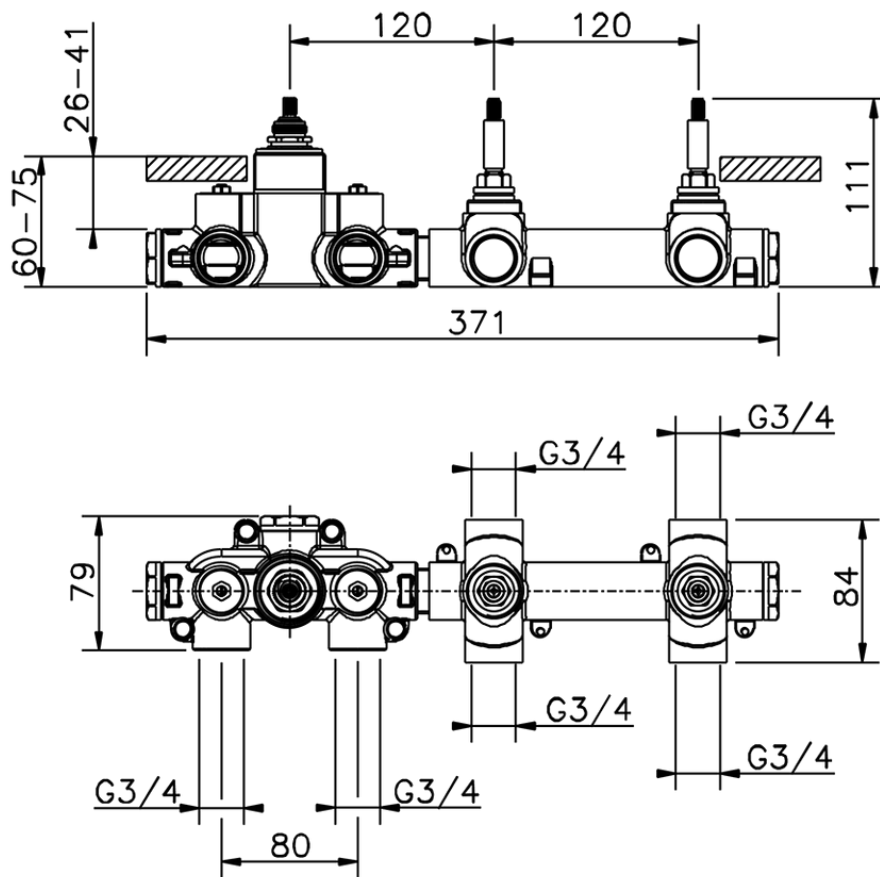

ZB01R200

<https://huberitalia.com/parte-incasso-termostatico-2-funzioni-incasso-zb01r200>

2024-11-24