

Miscelatore termostatico doccia CLINIC&TECHNICAL_CLT01030

MODELLO **CLT01030**

Miscelatore termostatico doccia, senza completo doccia, attacco per flessibile 1/2" M, con leva clinica

FINITURE DISPONIBILI



CARATTERISTICHE

Ricambio Cartuccia **24.04A.PP**

Cartuccia Termostatica Plus P 8X20

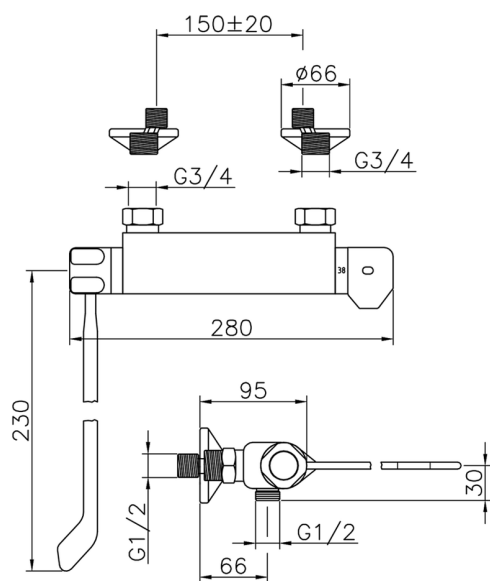

Termostatico

Il Termostatico Huber è il tuo personale gestore dell'acqua che ti aiuta a gestire e controllare acqua ed energia senza sprechi.



2024-11-21