

Bocca di erogazione COMPLEMENTI_64.04.

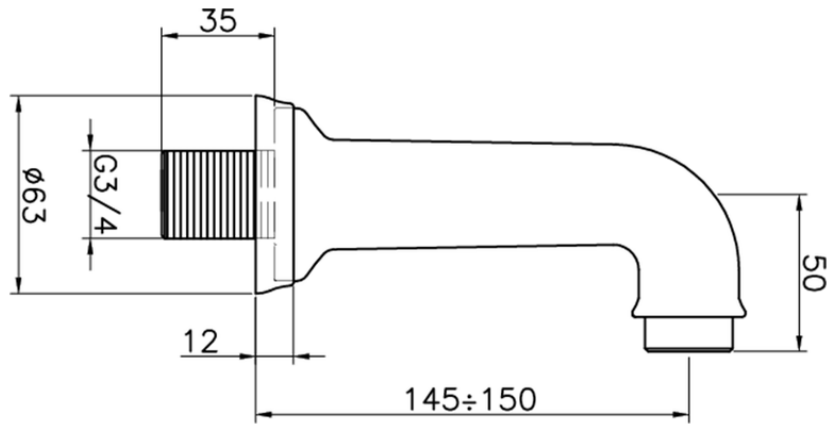

64.04.

<https://www.huberitalia.com/bocca-di-erogazione-complementi-64-04>

2024-12-22