

Parte esterna termostatico doccia incasso 1 uscita HARLOCK_HC007300

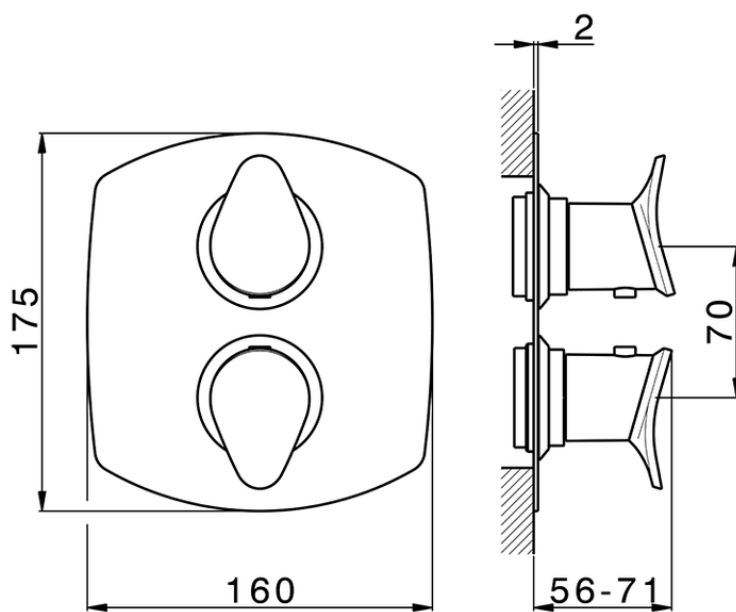

HC007300

<https://huberitalia.com/parte-esterna-termostatico-doccia-incasso-1-uscita-harlock-hc007300>

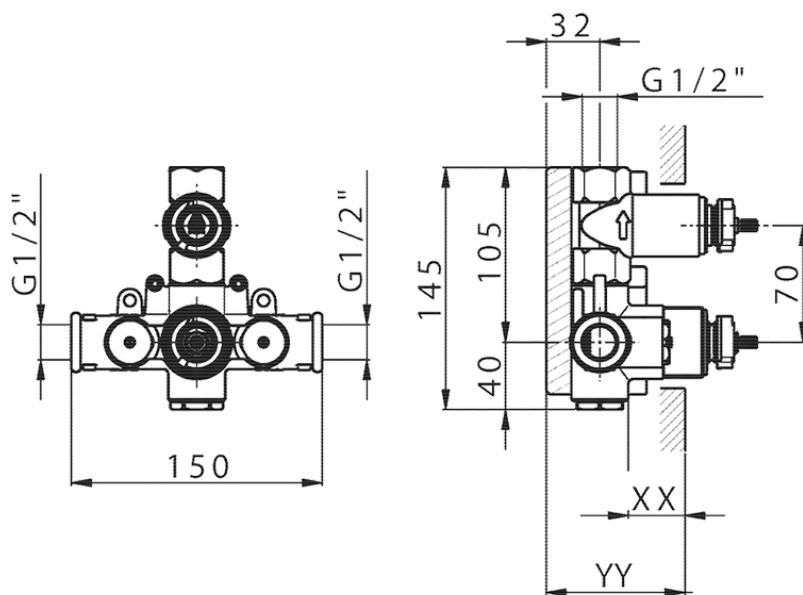

Piastra/Plate/Plaque/Platte/Placa

2-3mm: XX 25-40 YY 76-91

10 mm: XX 16-31 YY 65-80

ZB007300

<https://huberitalia.com/parte-incasso-termostatico-doccia-1-uscita-incasso-zb007300>

2024-11-23