

Parte esterna monocomando doccia incasso SOFT_SF003000



MODELLO **SF003000**

Parte esterna monocomando doccia incasso, senza parte incasso, per art. ZB005300

FINITURE DISPONIBILI



21 21 Cromo

CARATTERISTICHE

Installazione **Incasso**

Parti Incasso necessarie **ZB005300**

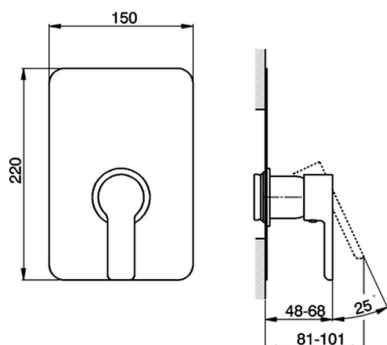

Parte incasso monocomando doccia INCASSO_ZB005300

MODELLO **ZB005300**

Parte incasso monocomando doccia, doccia incasso 1/2", senza parte esterna



FINITURE DISPONIBILI



04 04 Senza Finitura

CARATTERISTICHE

Installazione	Incasso
Ricambio Cartuccia	ZZ94035000
Cartuccia Monocomando 35 mm	
Incasso	1

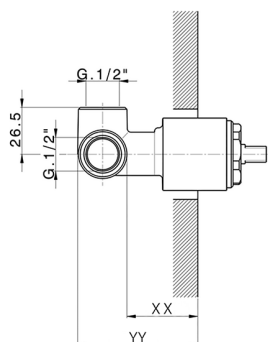

Piastra/Plate/Plaque/Platte/Placa
 2-3mm: XX 27-47 YY 54-74
 10mm: XX 16-40 YY 43-68



2024-12-22