

Parte esterna termostatico doccia incasso THERMO_VT007200

MODELLO **VT007200**

Parte esterna termostatico doccia incasso, senza rubinetto d'arresto, senza parte incasso, per art. ZB007201-ZB007221

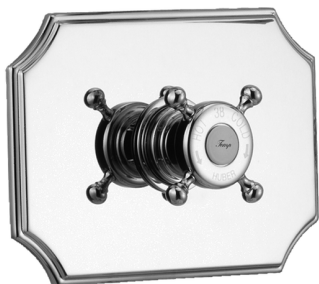

FINITURE DISPONIBILI

-  **21** 21 Cromo
-  **27** 27 Vecchio Bronzo
-  **2A** 2A Nichel Satinato Spazzolato
-  **2G** 2G Oro Antico
-  **2W** 2W Oro Spazzolato

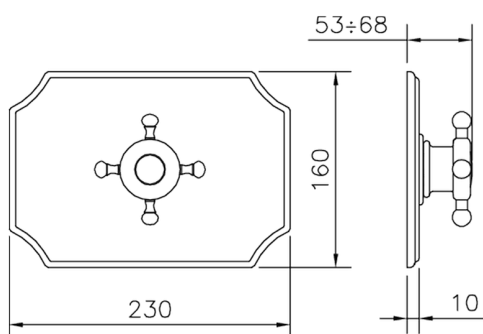

CARATTERISTICHE

Installazione **Incasso**
Parti Incasso necessarie **ZB007201**



Termostatico

Il Termostatico Huber è il tuo personale gestore dell'acqua che ti aiuta a gestire e controllare acqua ed energia senza sprechi.



Parte incasso termostatico doccia 1/2" INCASSO_ZB007201

MODELLO **ZB007201**

Parte incasso termostatico doccia 1/2", senza rubinetto d'arresto, senza parte esterna

FINITURE DISPONIBILI



04 04 Senza Finitura



CARATTERISTICHE

Installazione	Incasso
Ricambio Cartuccia	24.04A.PP
Cartuccia Termostatica Plus P 8X20	
Incasso	1

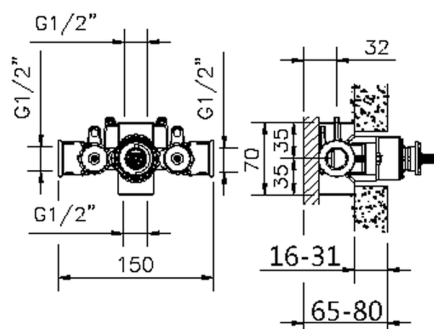

Termostatico

Il Termostatico Huber è il tuo personale gestore dell'acqua che ti aiuta a gestire e controllare acqua ed energia senza sprechi.



2024-11-21