

Bocca di erogazione COMPLEMENTI_27.01.

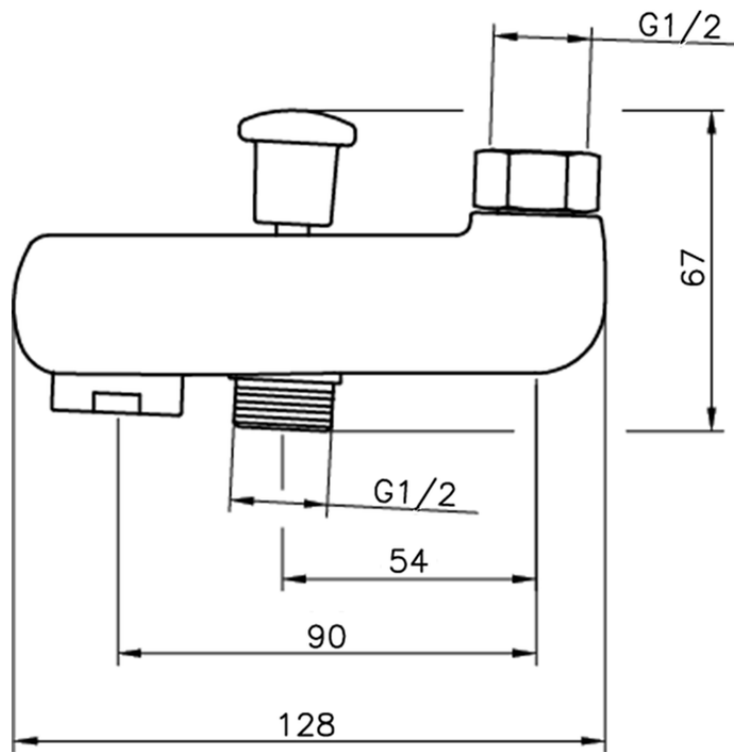

27.01.

<https://www.huberitalia.com/bocca-di-erogazione-complementi-27-01>

2024-12-22