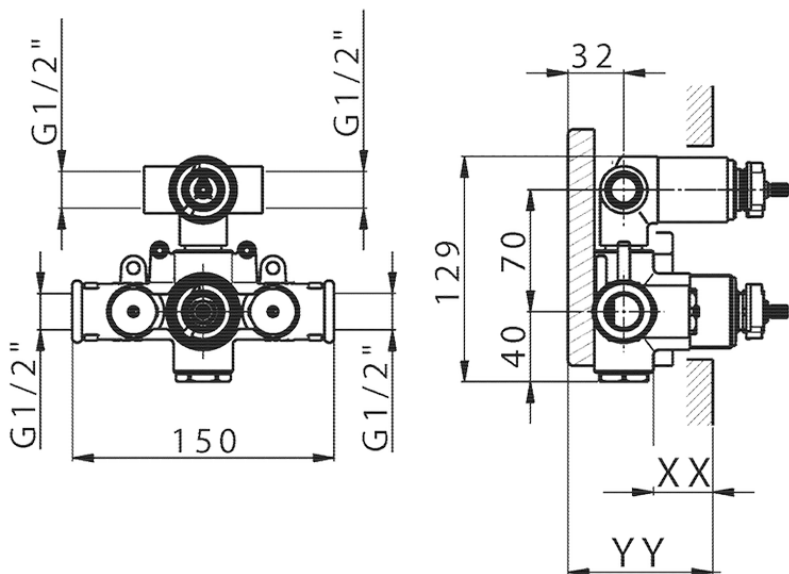

Parte incasso termostatico doccia 2 uscite INCASSO_ZB018101

Piastra/Plate/Plaque/Platte/Placa

2-3mm: XX 25-40 YY 76-91

10 mm: XX 16-31 YY 65-80