





Parte esterna termo doccia incasso 2 funzioni NUOVA EGO_NE01V200



MODELLO **NE01V200**

Parte esterna termo doccia incasso 2 funzioni, per art ZB01V200

FINITURE DISPONIBILI

-  **21** 21 Cromo
-  **2F** 2F Nichel Spazzolato
-  **40** 40 Nero Opaco
-  **4Q** 4Q Bianco Opaco

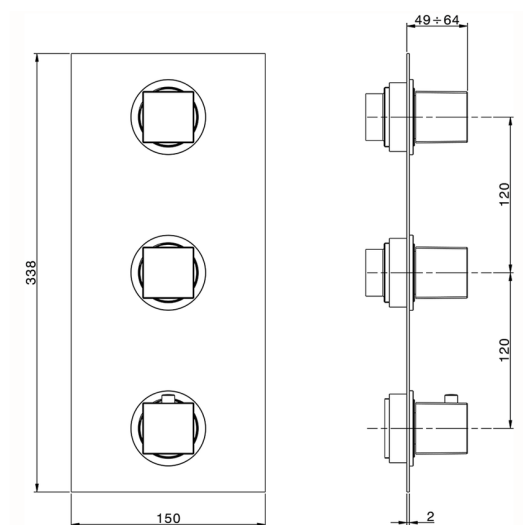

CARATTERISTICHE

Installazione **Incasso**
 Parti Incasso necessarie **ZB01V200**



Termostatico

Il Termostatico Huber è il tuo personale gestore dell'acqua che ti aiuta a gestire e controllare acqua ed energia senza sprechi.



Parte incasso termostatico doccia 2 funzioni INCASSO_ZB01V200

MODELLO **ZB01V200**

Parte incasso termostatico doccia 2 funzioni

FINITURE DISPONIBILI

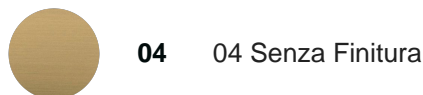

CARATTERISTICHE

Installazione	Incasso
Ricambio Cartuccia	23.51A.HF
Cartuccia Termostatica HF	
Incasso	1

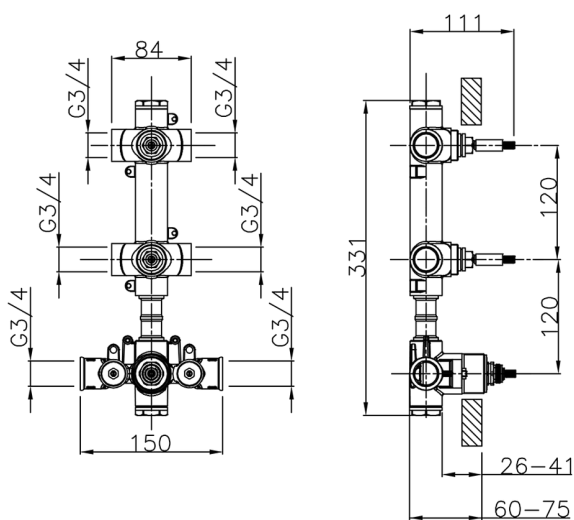

Termostatico

Il Termostatico Huber è il tuo personale gestore dell'acqua che ti aiuta a gestire e controllare acqua ed energia senza sprechi.



2024-12-22