





Completo Termostatico per One-Box ONE BOX_LY0BT030



MODELLO **LY0BT030**

Completo Termostatico per One-Box, con devia stop 1-2-3 uscite, profondità minima di installazione 67 mm, senza parte incasso, per art. ZB00B030-ZB00B031

FINITURE DISPONIBILI

-  **21** 21 Cromo
-  **2B** 2B Nichel Lucido
-  **2F** 2F Nichel Spazzolato
-  **40** 40 Nero Opaco
-  **4Q** 4Q Bianco Opaco

CARATTERISTICHE

Ricambio Cartuccia **24.04A.PP**
Cartuccia Termostatica Plus P 8X20
 Installazione **Incasso**
 Parti Incasso necessarie **ZB00B031**
ZB00B030



DeviaStop

La tecnologia Devia Stop di Huber consente con un semplice movimento rotativo di gestire la portata dell'acqua e di scegliere la modalità d'erogazione (soffione, doccia a mano).



Termostatico

Il Termostatico Huber è il tuo personale gestore dell'acqua che ti aiuta a gestire e controllare acqua ed energia senza sprechi.



Completo Termostatico per One-Box ONE BOX_LY0BT030

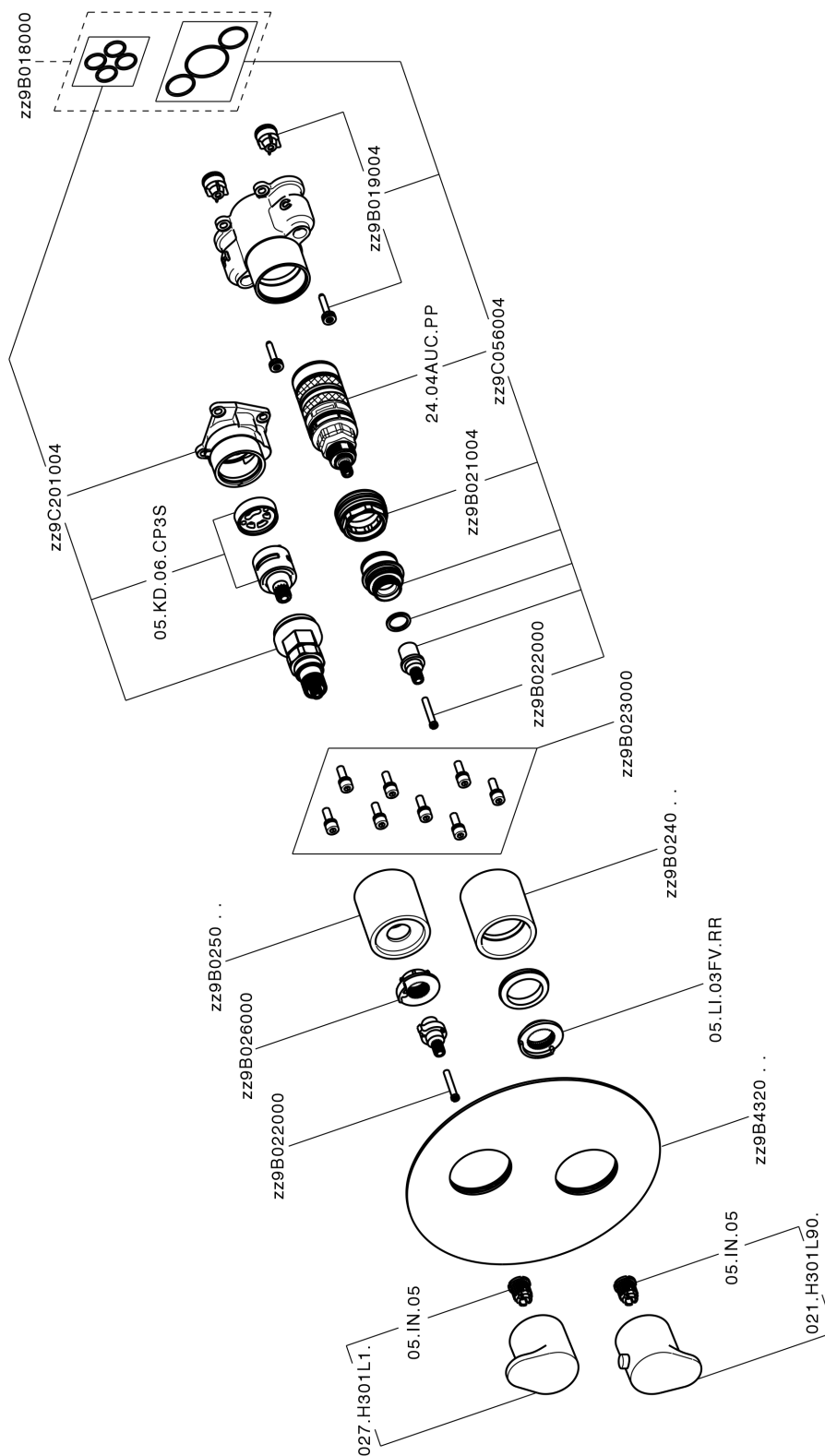

LY0BT030

<https://www.huberitalia.com/completo-termostatico-per-one-box-one-box-ly0bt030>

One-Box Universale per incasso ONE BOX_ZB00B031



MODELLO **ZB00B031**

One-Box Universale per incasso, per termostatico o monocomando 1 o 2 o 3 uscite, senza parte esterna, con silenziosi, con guarnizione per sigillatura

FINITURE DISPONIBILI

 **04** 04 Senza Finitura

CARATTERISTICHE

Incasso **1**
Installazione **Incasso**



Termostatico

Il Termostatico Huber è il tuo personale gestore dell'acqua che ti aiuta a gestire e controllare acqua ed energia senza sprechi.



One-Box Universale per incasso ONE BOX_ZB00B030

MODELLO **ZB00B030**

One-Box Universale per incasso, per termostatico o monocomando 1 o 2 o 3 uscite, senza parte esterna, senza silenzianti, con guarnizione per sigillatura

FINITURE DISPONIBILI

 **04** 04 Senza Finitura

CARATTERISTICHE

Incasso **1**
Installazione **Incasso**

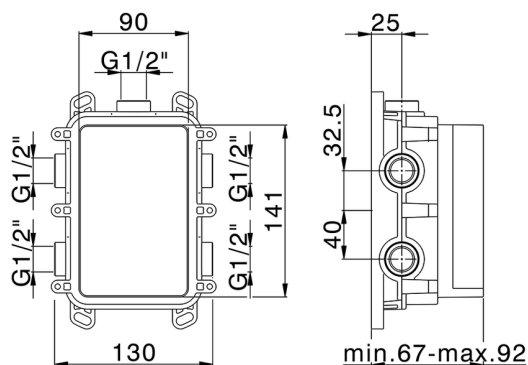

Termostatico

Il Termostatico Huber è il tuo personale gestore dell'acqua che ti aiuta a gestire e controllare acqua ed energia senza sprechi.



2024-12-22