

Parte esterna termo doccia incasso 2 funzioni NUOVA EGO_NE01R200

MODELLO **NE01R200**

Parte esterna termo doccia incasso 2 funzioni, per art.ZB01R200

FINITURE DISPONIBILI

-  **21** 21 Cromo
-  **2F** 2F Nichel Spazzolato
-  **40** 40 Nero Opaco
-  **4Q** 4Q Bianco Opaco

CARATTERISTICHE

Installazione **Incasso**
 Parti Incasso necessarie **ZB01R200**

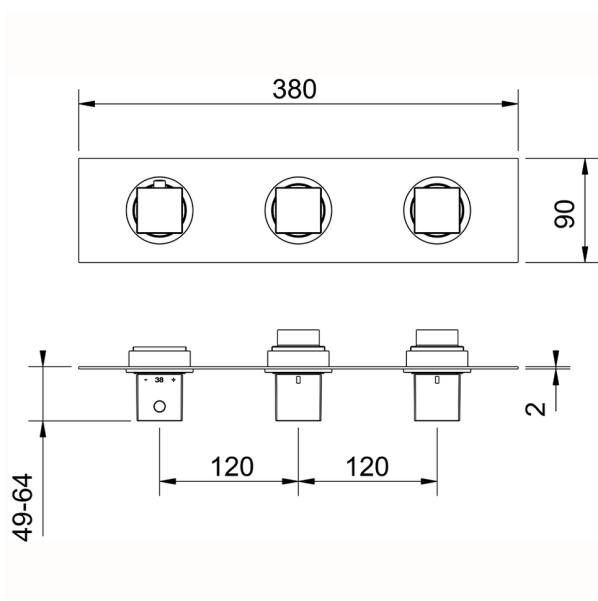
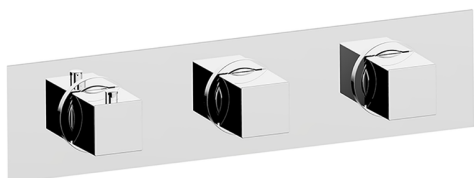

Termostatico

Il Termostatico Huber è il tuo personale gestore dell'acqua che ti aiuta a gestire e controllare acqua ed energia senza sprechi.



Parte incasso termostatico 2 funzioni INCASSO_ZB01R200
MODELLO ZB01R200

Parte incasso termostatico 2 funzioni

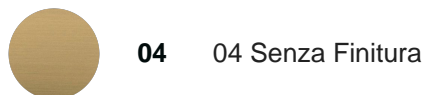
FINITURE DISPONIBILI

04 04 Senza Finitura

CARATTERISTICHE

 Installazione **Incasso**

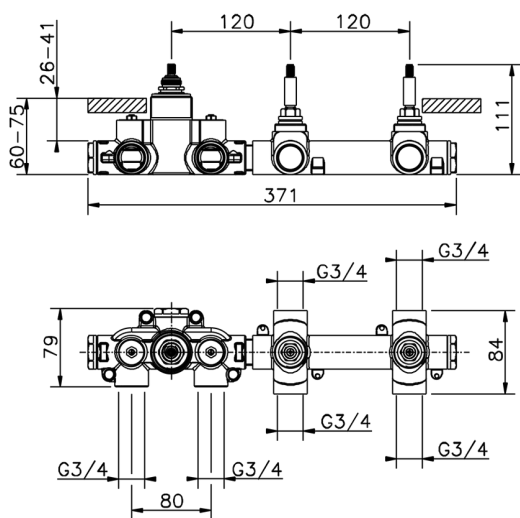
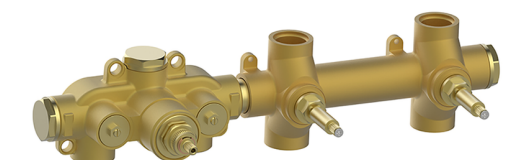
 Ricambio Cartuccia **23.51A.HF**
Cartuccia Termostatica HF

 Incasso **1**

Termostatico

Il Termostatico Huber è il tuo personale gestore dell'acqua che ti aiuta a gestire e controllare acqua ed energia senza sprechi.



2024-12-22