

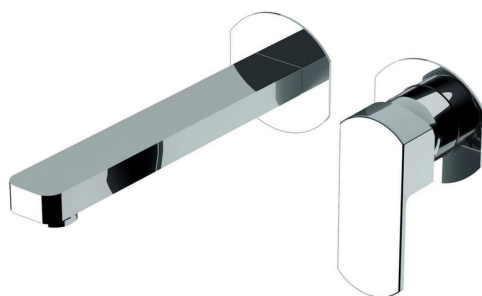





Parte esterna monocomando lavabo a parete DADO_DD005512

MODELLO **DD005512**

Parte esterna monocomando lavabo a parete, senza parte incasso, bocca L.250 mm, per art. Easy-Box ZB002450 e art. ZB025510



FINITURE DISPONIBILI

-  **21** 21 Cromo
-  **2B** 2B Nichel Lucido
-  **2F** 2F Nichel Spazzolato
-  **40** 40 Nero Opaco
-  **4Q** 4Q Bianco Opaco

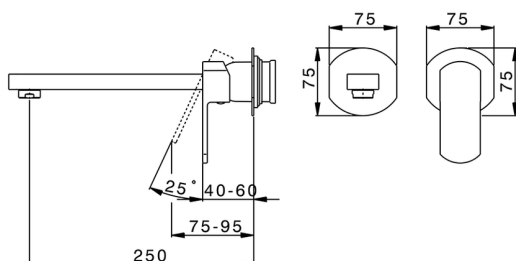

CARATTERISTICHE

Installazione **Incasso**
 Parti Incasso necessarie **ZB002450**



Parte incasso monocomando lavabo a parete Easy-Box INCASSO_ZB002450

MODELLO **ZB002450**

Parte incasso monocomando lavabo a parete Easy-Box, con scatola di protezione, senza parte esterna

FINITURE DISPONIBILI

 **04** 04 Senza Finitura

CARATTERISTICHE

Incasso **1**

Ricambio Cartuccia **ZZ95409000**

Cartuccia Monocomando 35 mm

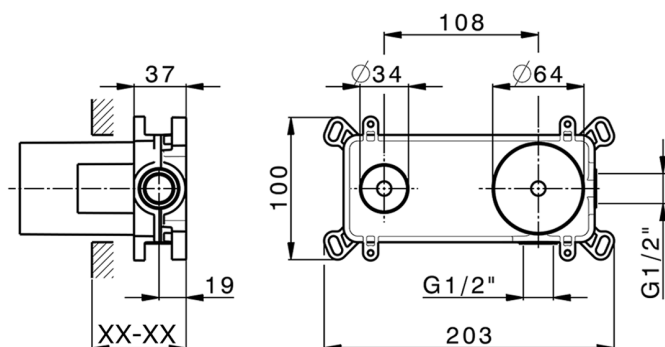
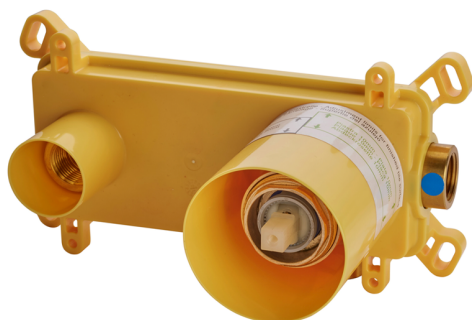

Piastra/Plate/Plaque/Platte/Placa

2-3mm: XX 56-76

10mm: XX 48-68



EcoStop

Con il Dispositivo EcoStop l'apertura dell'acqua avviene con un punto duro al 50% circa della portata. Un fermo a metà apertura, da vincere con una leggera forza solo e soltanto quando ci sia una reale necessità di richiesta d'acqua alla massima portata. Ciò permette di consumare fino al 50% in meno di acqua.



2024-11-24