

Parte incasso monocomando free-standing INCASSO_ZB004510

MODELLO **ZB004510**

Parte incasso a pavimento, per monocomando free-standing

FINITURE DISPONIBILI

 **04** 04 Senza Finitura

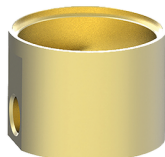

CARATTERISTICHE

Installazione	Incasso
Incasso	1

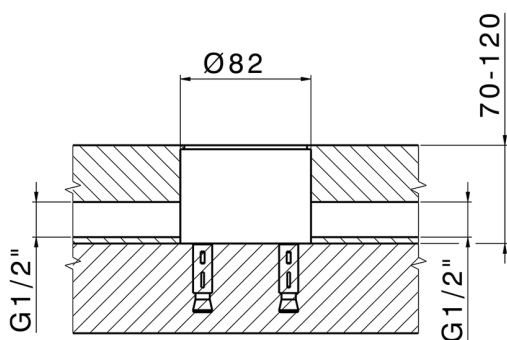

2024-12-22