

## Parte esterna termostatico doccia incasso NUOVA KIRUNA\_KT007200

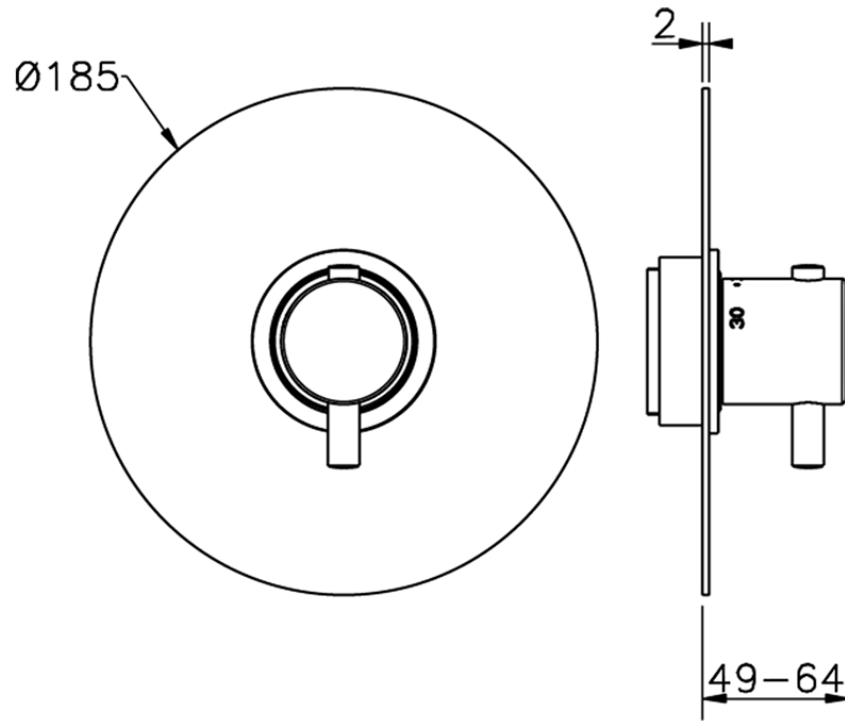

K2007200

<https://www.huberitalia.com/parte-esterna-termostatico-doccia-incasso-nuova-kiruna-kt007200>



## Piastra/Plate/Plaque/Platte/Placa

2-3mm: XX 25-40 YY 76-91

10mm: XX 16-31 YY 65-80

ZB007221

<https://www.huberitalia.com/parte-incasso-termostatico-doccia-3-4-incasso-zb007221>

2025-01-21