







## Parte esterna termostatico doccia incasso NUOVA KIRUNA\_KT007200

MODELLO **K2007200**

Parte esterna termostatico incasso, senza rubinetto d'arresto, senza parte incasso, per art. ZB007221

### FINITURE DISPONIBILI

-  **21** 21 Cromo
-  **26** 26 Vecchio Rame
-  **2F** 2F Nichel Spazzolato
-  **2W** 2W Oro Spazzolato
-  **40** 40 Nero Opaco
-  **4Q** 4Q Bianco Opaco

### CARATTERISTICHE

Installazione **Incasso**  
 Parti Incasso necessarie **ZB007221**

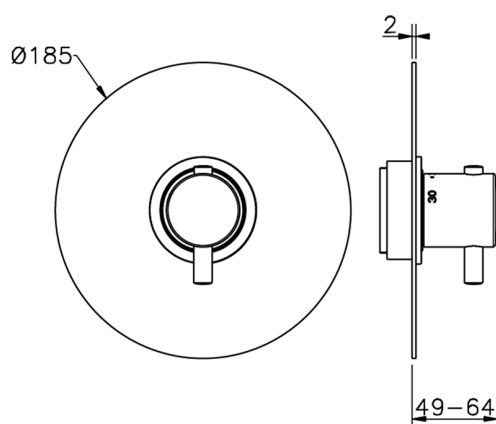

### Termostatico

Il Termostatico Huber è il tuo personale gestore dell'acqua che ti aiuta a gestire e controllare acqua ed energia senza sprechi.



## Parte incasso termostatico doccia 3/4" INCASSO\_ZB007221

MODELLO **ZB007221**

Parte incasso termostatico 3/4", senza rubinetto d'arresto, senza parte esterna

FINITURE DISPONIBILI

 **04** 04 Senza Finitura

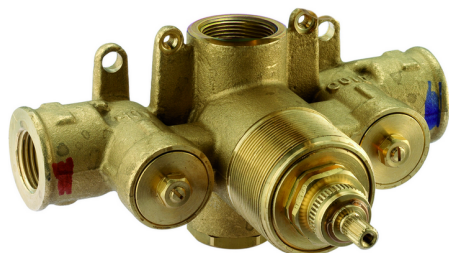

CARATTERISTICHE

Installazione	<b>Incasso</b>
Ricambio Cartuccia	<b>23.51A.HF</b>
<b>Cartuccia Termostatica HF</b>	
Incasso	<b>1</b>

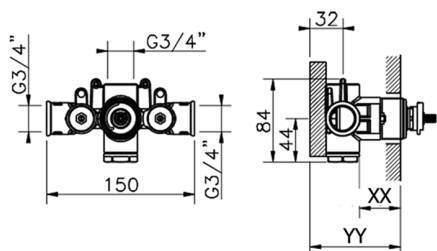

Piastra/Plate/Plaque/Platte/Placa  
 2-3mm: XX 25-40 YY 76-91  
 10mm: XX 16-31 YY 65-80



### Termostatico

Il Termostatico Huber è il tuo personale gestore dell'acqua che ti aiuta a gestire e controllare acqua ed energia senza sprechi.



2025-02-23