

Miscelatore monocomando doccia incasso ZARA_ZR000304

MODELLO **ZR000304**

Miscelatore monocomando doccia incasso, completo di parte incasso

FINITURE DISPONIBILI



21 21 Cromo

CARATTERISTICHE

Ricambio Cartuccia **ZZ96779000**

Cartuccia Monocomando 35 mm

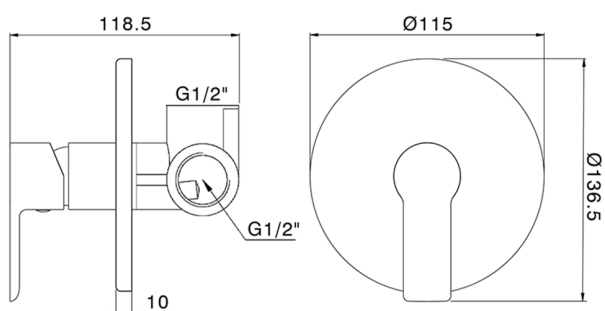

2024-11-21