

Bocca di erogazione COMPLEMENTI_27.01.

MODELLO **27.01.**

Bocca di erogazione

FINITURE DISPONIBILI



CARATTERISTICHE

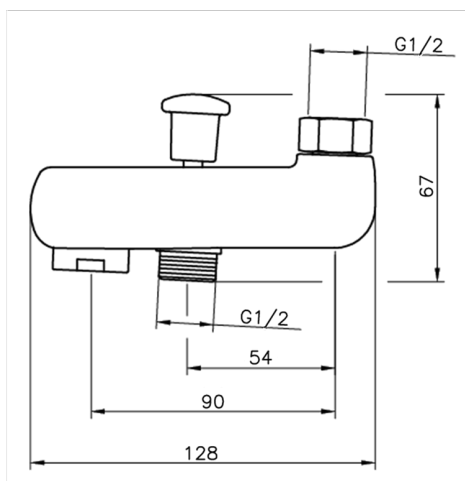

2024-10-22