

## Parte esterna termostatico doccia incasso THERMO\_VT007200

MODELLO **VT007200**

Parte esterna termostatico doccia incasso, senza rubinetto d'arresto, senza parte incasso, per art. ZB007201-ZB007221

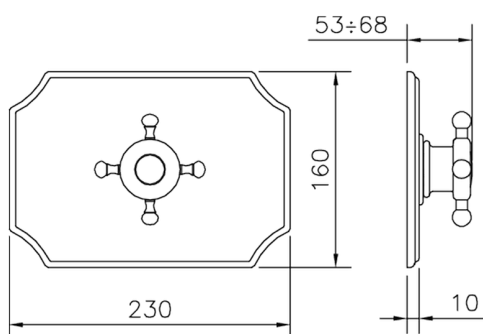
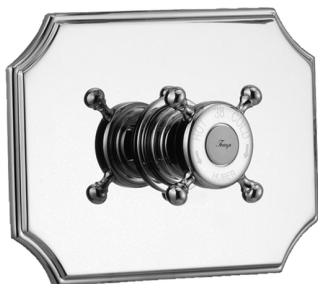

### FINITURE DISPONIBILI

-  **21** 21 Cromo
-  **27** 27 Vecchio Bronzo
-  **2A** 2A Nichel Satinato Spazzolato
-  **2G** 2G Oro Antico
-  **2W** 2W Oro Spazzolato

### CARATTERISTICHE

Installazione **Incasso**  
 Parti Incasso necessarie **ZB007201**



### Termostatico

Il Termostatico Huber è il tuo personale gestore dell'acqua che ti aiuta a gestire e controllare acqua ed energia senza sprechi.



## Parte incasso termostatico doccia 1/2" INCASSO\_ZB007201

MODELLO **ZB007201**

Parte incasso termostatico doccia 1/2", senza rubinetto d'arresto, senza parte esterna

FINITURE DISPONIBILI



**04** 04 Senza Finitura

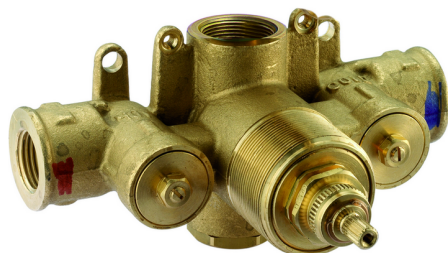

CARATTERISTICHE

Installazione	<b>Incasso</b>
Ricambio Cartuccia	<b>24.04A.PP</b>
<b>Cartuccia Termostatica Plus P 8X20</b>	
Incasso	<b>1</b>

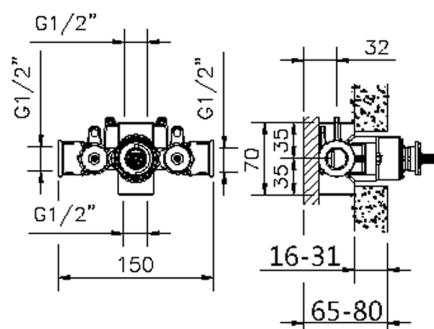

### Termostatico

Il Termostatico Huber è il tuo personale gestore dell'acqua che ti aiuta a gestire e controllare acqua ed energia senza sprechi.



2024-12-22