

Parte esterna termostatico incasso PUSH&SHOWER_PS0G1010

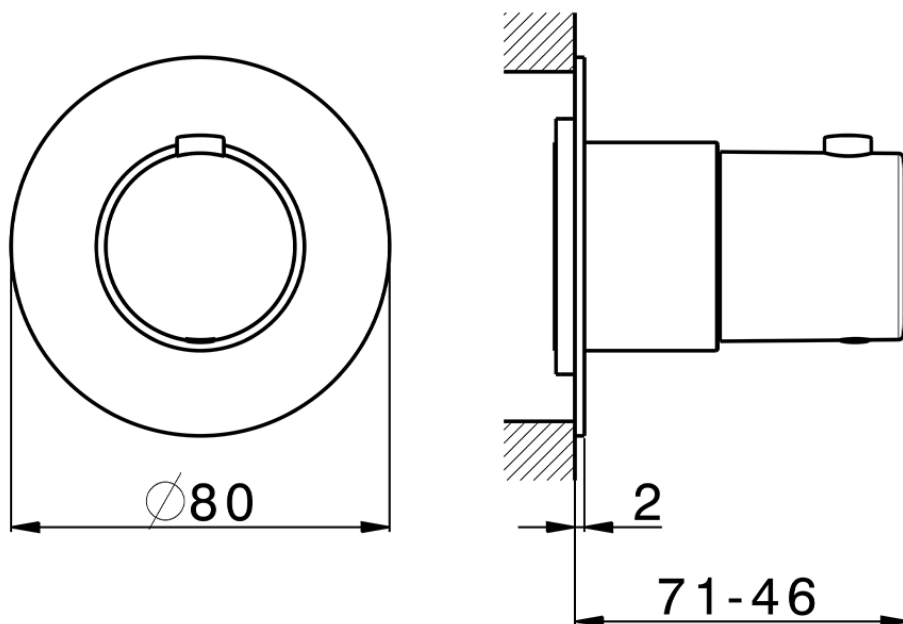

PS0G1010

<https://huberitalia.com/parte-esterna-termostatico-incasso-pushshower-ps0g1010>



ZBOG1000

<https://huberitalia.com/parte-incasso-termostatico-incasso-zb0g1000>

2024-11-21