

Parte esterna termostatico doccia incasso 2 uscite CHRONOS_CR019641



MODELLO **CR019641**

Parte esterna termostatico doccia incasso 2 uscite, con deviaspout 2 uscite, doccetta monogetto minimale D.24mm in Ottone, flessibile liscio SUPREME 150 cm, senza parte incasso - per art.ZB019340

FINITURE DISPONIBILI

-  **21** 21 Cromo
-  **2F** 2F Nichel Spazzolato
-  **2Q** 2Q Black Titanium

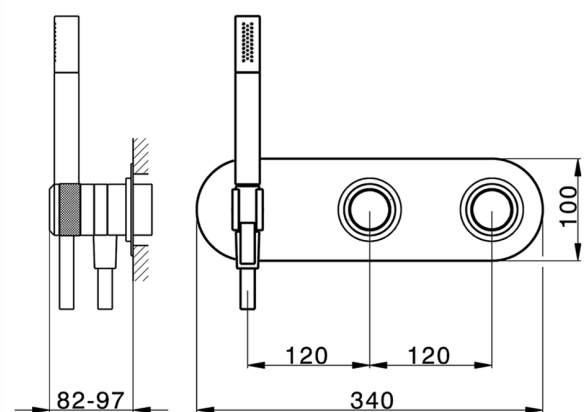

CARATTERISTICHE

Installazione **Incasso**
Parti Incasso necessarie **ZB019340**



Termostatico

Il Termostatico Huber è il tuo personale gestore dell'acqua che ti aiuta a gestire e controllare acqua ed energia senza sprechi.



Parte incasso termostatico vasca 2 uscite INCASSO_ZB019340
MODELLO ZB019340

Parte incasso termostatico doccia 2 uscite, senza parte esterna

FINITURE DISPONIBILI

04 04 Senza Finitura

CARATTERISTICHE

Installazione	Incasso
Ricambio Cartuccia	24.04A.PP
Cartuccia Termostatica Plus P 8X20	
Incasso	1

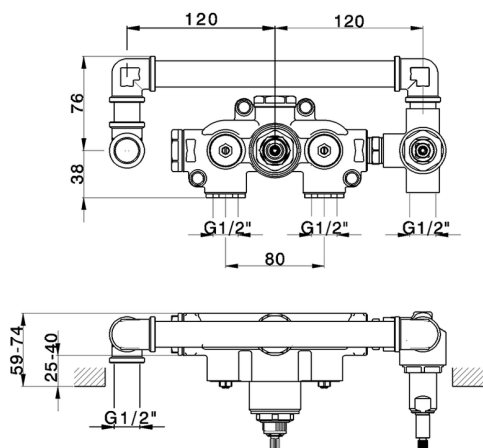
Termostatico

Il Termostatico Huber è il tuo personale gestore dell'acqua che ti aiuta a gestire e controllare acqua ed energia senza sprechi.



2024-11-21