

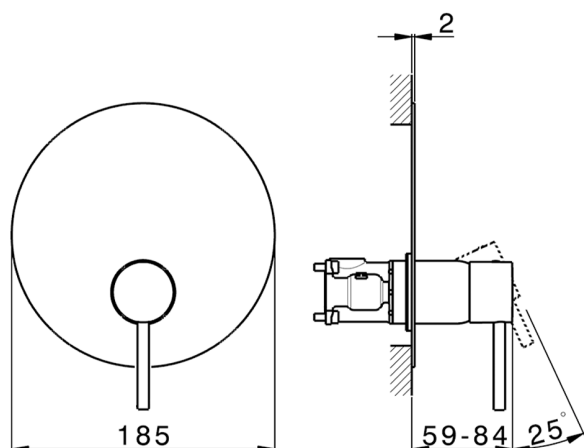





Completo Monocomando per One-Box ONE BOX_K20BM010



MODELLO **K20BM010**

Completo Monocomando per One-Box, 1 uscita, profondità minima di installazione 67 mm, senza parte incasso, per art. ZB00B030-ZB00B031

FINITURE DISPONIBILI

-  **21** 21 Cromo
-  **26** 26 Vecchio Rame
-  **2F** 2F Nichel Spazzolato
-  **2W** 2W Oro Spazzolato
-  **40** 40 Nero Opaco
-  **4Q** 4Q Bianco Opaco

CARATTERISTICHE

Ricambio Cartuccia **ZZ97179000**

Cartuccia Monocomando 35 mm

Installazione **Incasso**

Parti Incasso necessarie **ZB00B031**

ZB00B030



One-Box Universale per incasso ONE BOX_ZB00B031



MODELLO **ZB00B031**

One-Box Universale per incasso, per termostatico o monocomando 1 o 2 o 3 uscite, senza parte esterna, con silenziosi, con guarnizione per sigillatura

FINITURE DISPONIBILI

 **04** 04 Senza Finitura

CARATTERISTICHE

Incasso **1**
Installazione **Incasso**



Termostatico

Il Termostatico Huber è il tuo personale gestore dell'acqua che ti aiuta a gestire e controllare acqua ed energia senza sprechi.



One-Box Universale per incasso ONE BOX_ZB00B030



MODELLO **ZB00B030**

One-Box Universale per incasso, per termostatico o monocomando 1 o 2 o 3 uscite, senza parte esterna, senza silenzianti, con guarnizione per sigillatura

FINITURE DISPONIBILI

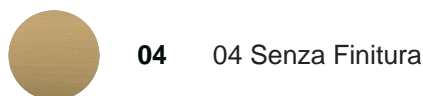

CARATTERISTICHE

Incasso	1
Installazione	Incasso



Termostatico

Il Termostatico Huber è il tuo personale gestore dell'acqua che ti aiuta a gestire e controllare acqua ed energia senza sprechi.



2024-10-22