

Parte incasso monocomando doccia INCASSO_ZB002300

MODELLO **ZB002300**

Parte incasso monocomando 2 uscite, doccia incasso 1/2", senza parte esterna



FINITURE DISPONIBILI



04 04 Senza Finitura

CARATTERISTICHE

Incasso **1**

Ricambio Cartuccia **ZZ92909000**

Cartuccia Monocomando 43 mm

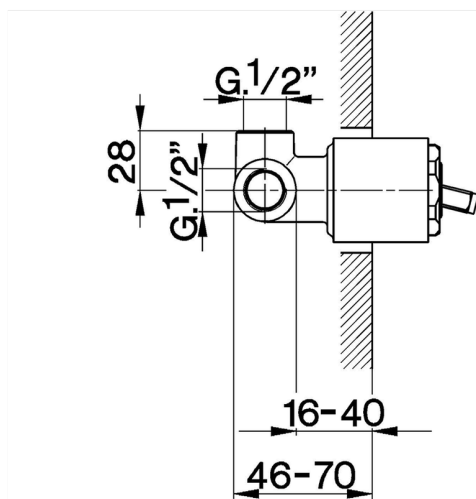

2024-11-21